



# SGM2019

## Low Power, Low Dropout, RF Linear Regulator

### GENERAL DESCRIPTION

The SGM2019 is a low power and low dropout voltage RF linear regulator. It is capable of supplying 300mA output current with typical dropout voltage of only 270mV. The operating input voltage range is from 2.5V to 5.5V. The fixed output voltage range is from 1.2V to 3.3V and the adjustable output voltage range is from 1.2V to 5.0V.

Other features include logic-controlled shutdown mode, output current limit and thermal shutdown protection.

The SGM2019 is available in Green SC70-5 and SOT-23-5 packages. It operates over an operating temperature range of -40°C to +85°C.

### APPLICATIONS

- Modems
- MP3 Players
- Cellular Telephones
- PCMCIA Cards
- Palmtop Computers
- Portable Electronics

### FEATURES

- **Operating Input Voltage Range: 2.5V to 5.5V**
- **Fixed Output Voltages:**  
1.2V, 1.5V, 1.8V, 2.5V, 2.6V, 2.8V, 2.85V, 3.0V, 3.3V
- **Adjustable Output Voltage Range: 1.2V to 5.0V**
- **Output Voltage Accuracy:  $\pm 2.5\%$  at +25°C**
- **Low Output Noise: 30 $\mu$ V<sub>RMS</sub> (TYP)**
- **Low Dropout Voltage: 270mV (TYP) at 300mA**
- **High PSRR: 74dB (TYP) at 1kHz**
- **Shutdown Current: 0.01 $\mu$ A (TYP)**
- **Thermal Shutdown Protection**
- **Output Current Limit**
- **-40°C to +85°C Operating Temperature Range**
- **Available in Green SC70-5 and SOT-23-5 Packages**

### PRODUCT NAME STRUCTURE

SGM2019 - X X X G / TR

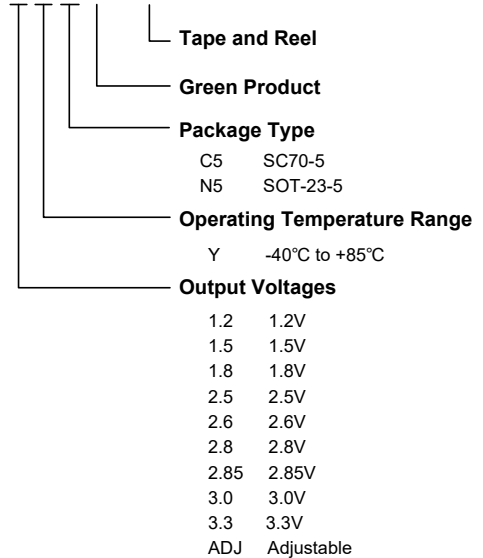

## PACKAGE/ORDERING INFORMATION

MODEL	PACKAGE DESCRIPTION	SPECIFIED TEMPERATURE RANGE	ORDERING NUMBER	PACKAGE MARKING	PACKING OPTION
SGM2019-1.2	SOT-23-5	-40°C to +85°C	SGM2019-1.2YN5G/TR	YJ12	Tape and Reel, 3000
SGM2019-1.2	SC70-5	-40°C to +85°C	SGM2019-1.2YC5G/TR	YJ12	Tape and Reel, 3000
SGM2019-1.5	SOT-23-5	-40°C to +85°C	SGM2019-1.5YN5G/TR	YJ15	Tape and Reel, 3000
SGM2019-1.5	SC70-5	-40°C to +85°C	SGM2019-1.5YC5G/TR	YJ15	Tape and Reel, 3000
SGM2019-1.8	SOT-23-5	-40°C to +85°C	SGM2019-1.8YN5G/TR	YJ18	Tape and Reel, 3000
SGM2019-1.8	SC70-5	-40°C to +85°C	SGM2019-1.8YC5G/TR	YJ18	Tape and Reel, 3000
SGM2019-2.5	SOT-23-5	-40°C to +85°C	SGM2019-2.5YN5G/TR	YJ25	Tape and Reel, 3000
SGM2019-2.5	SC70-5	-40°C to +85°C	SGM2019-2.5YC5G/TR	YJ25	Tape and Reel, 3000
SGM2019-2.6	SOT-23-5	-40°C to +85°C	SGM2019-2.6YN5G/TR	YJ26	Tape and Reel, 3000
SGM2019-2.6	SC70-5	-40°C to +85°C	SGM2019-2.6YC5G/TR	YJ26	Tape and Reel, 3000
SGM2019-2.8	SOT-23-5	-40°C to +85°C	SGM2019-2.8YN5G/TR	YJ28	Tape and Reel, 3000
SGM2019-2.8	SC70-5	-40°C to +85°C	SGM2019-2.8YC5G/TR	YJ28	Tape and Reel, 3000
SGM2019-2.85	SOT-23-5	-40°C to +85°C	SGM2019-2.85YN5G/TR	YJ2J	Tape and Reel, 3000
SGM2019-2.85	SC70-5	-40°C to +85°C	SGM2019-2.85YC5G/TR	YJ2J	Tape and Reel, 3000
SGM2019-3.0	SOT-23-5	-40°C to +85°C	SGM2019-3.0YN5G/TR	YJ30	Tape and Reel, 3000
SGM2019-3.0	SC70-5	-40°C to +85°C	SGM2019-3.0YC5G/TR	YJ30	Tape and Reel, 3000
SGM2019-3.3	SOT-23-5	-40°C to +85°C	SGM2019-3.3YN5G/TR	YJ33	Tape and Reel, 3000
SGM2019-3.3	SC70-5	-40°C to +85°C	SGM2019-3.3YC5G/TR	YJ33	Tape and Reel, 3000
SGM2019-ADJ	SOT-23-5	-40°C to +85°C	SGM2019-ADJYN5G/TR	YJAA	Tape and Reel, 3000
SGM2019-ADJ	SC70-5	-40°C to +85°C	SGM2019-ADJYC5G/TR	YJAA	Tape and Reel, 3000

Green (RoHS & HSF): SG Micro Corp defines "Green" to mean Pb-Free (RoHS compatible) and free of halogen substances. If you have additional comments or questions, please contact your SGMICRO representative directly.

### ABSOLUTE MAXIMUM RATINGS

IN to GND .....	-0.3V to 6V
Output Short-Circuit Duration .....	Infinite
EN to GND.....	-0.3V to $V_{IN}$
OUT, BP/FB to GND.....	-0.3V to ( $V_{IN} + 0.3V$ )
Power Dissipation, $P_D$ @ $T_A = +25^\circ C$	
SOT-23-5.....	0.4W
SC70-5.....	0.3W
Package Thermal Resistance	
SOT-23-5, $\theta_{JA}$ .....	260°C/W
SC70-5, $\theta_{JA}$ .....	330°C/W
Junction Temperature.....	+150°C
Storage Temperature Range .....	-65°C to +150°C
Lead Temperature (Soldering, 10s).....	+260°C
ESD Susceptibility	
HBM.....	4000V
MM.....	400V

### RECOMMENDED OPERATING CONDITIONS

Operating Temperature Range .....	-40°C to +85°C
-----------------------------------	----------------

### OVERSTRESS CAUTION

Stresses beyond those listed in Absolute Maximum Ratings may cause permanent damage to the device. Exposure to absolute maximum rating conditions for extended periods may affect reliability. Functional operation of the device at any conditions beyond those indicated in the Recommended Operating Conditions section is not implied.

### ESD SENSITIVITY CAUTION

This integrated circuit can be damaged if ESD protections are not considered carefully. SGMICRO recommends that all integrated circuits be handled with appropriate precautions. Failure to observe proper handling and installation procedures can cause damage. ESD damage can range from subtle performance degradation to complete device failure. Precision integrated circuits may be more susceptible to damage because even small parametric changes could cause the device not to meet the published specifications.

### DISCLAIMER

SG Micro Corp reserves the right to make any change in circuit design, or specifications without prior notice.

## PIN CONFIGURATIONS

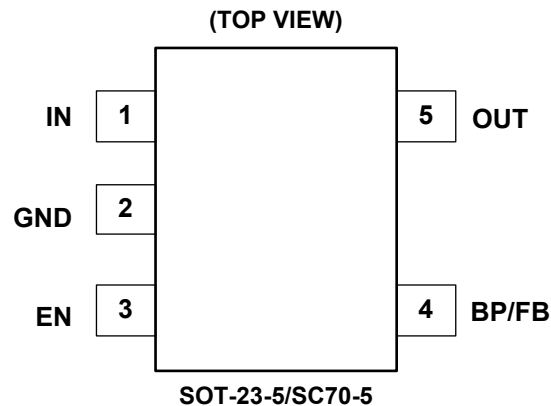

## PIN DESCRIPTION

PIN	NAME	FUNCTION
SC70-5/SOT-23-5		
1	IN	Input Voltage Supply Pin. It is recommended to use a 1 $\mu$ F or larger ceramic capacitor from IN pin to ground to get good power supply decoupling. This ceramic capacitor should be placed as close as possible to IN pin.
2	GND	Ground.
3	EN	Enable Pin. Drive EN high to turn on the regulator. Drive EN low to turn off the regulator.
4	BP	Reference-Noise Bypass Pin (fixed voltage version only). Bypass with an external capacitor $C_{BP}$ can reduce output noise to very low level.
	FB	Feedback Voltage Input Pin (adjustable voltage version only). Connect this pin to the midpoint of an external resistor divider to adjust the output voltage. Place the resistors as close as possible to this pin.
5	OUT	Regulator Output Pin.

## ELECTRICAL CHARACTERISTICS

(V<sub>IN</sub> = V<sub>OUT (NOMINAL)</sub> + 0.5V<sup>(1)</sup>, Full = -40°C to +85°C, unless otherwise noted.)

PARAMETER	SYMBOL	CONDITIONS	TEMP	MIN	TYP	MAX	UNITS
Input Voltage	V <sub>IN</sub>		+25°C	2.5		5.5	V
Output Voltage Accuracy <sup>(1)</sup>		I <sub>OUT</sub> = 0.1mA	+25°C	-2.5		2.5	%
Maximum Output Current <sup>(1)</sup>		SOT-23-5	+25°C	300			mA
		V <sub>OUT</sub> = 1.2V, 1.5V, 1.8V, SC70-5		150			
		V <sub>OUT</sub> > 2V, SC70-5		250			
Current Limit <sup>(1)</sup>	I <sub>LIMIT</sub>		+25°C	310	500		mA
Ground Pin Current	I <sub>Q</sub>	No load, EN = 2V	+25°C		100	200	μA
Dropout Voltage <sup>(2)</sup>		I <sub>OUT</sub> = 1mA	+25°C		0.9		mV
		I <sub>OUT</sub> = 300mA			270	400	
Line Regulation <sup>(1)</sup>	ΔV <sub>LNR</sub>	V <sub>IN</sub> = 2.5V or (V <sub>OUT</sub> + 0.5V) to 5.5V, I <sub>OUT</sub> = 1mA	+25°C		0.02	0.05	%/V
Load Regulation	ΔV <sub>LDR</sub>	I <sub>OUT</sub> = 0.1mA to 300mA, C <sub>OUT</sub> = 1μF, V <sub>OUT</sub> > 2V	+25°C		0.002	0.005	%/mA
		I <sub>OUT</sub> = 0.1mA to 300mA, C <sub>OUT</sub> = 1μF, V <sub>OUT</sub> ≤ 2V			0.004	0.008	
Output Voltage Noise	e <sub>n</sub>	f = 10Hz to 100kHz, C <sub>BP</sub> = 0.01μF, C <sub>OUT</sub> = 10μF	+25°C		30		μV <sub>RMS</sub>
Power Supply Rejection Ratio	PSRR	C <sub>BP</sub> = 0.1μF, I <sub>OUT</sub> = 50mA, C <sub>OUT</sub> = 1μF, V <sub>IN</sub> = V <sub>OUT</sub> + 1V	f = 217Hz	+25°C		77	dB
			f = 1kHz	+25°C		74	
<b>Shutdown<sup>(3)</sup></b>							
EN Input Threshold	V <sub>IH</sub>	V <sub>IN</sub> = 2.5V to 5.5V, V <sub>EN</sub> = -0.3V to V <sub>IN</sub>	Full	1.5			V
	V <sub>IL</sub>		Full			0.3	
EN Input Bias Current	I <sub>B(SHDN)</sub>	EN = 0V or EN = 5.5V	+25°C		0.01	1	μA
			Full		0.01		
Shutdown Supply Current	I <sub>Q(SHDN)</sub>	EN = 0.4V	Full		0.01		μA
Shutdown Exit Delay <sup>(4)</sup>		C <sub>BP</sub> = 0.01μF, C <sub>OUT</sub> = 1μF, No Load	+25°C		30		μs
<b>Thermal Protection</b>							
Thermal Shutdown Temperature	T <sub>SHDN</sub>				150		°C
Thermal Shutdown Hysteresis	ΔT <sub>SHDN</sub>				15		°C

## NOTES:

- V<sub>IN</sub> = (V<sub>OUT (NOMINAL)</sub> + 0.5V) or 2.5V, whichever is greater.
- The dropout voltage is defined as V<sub>IN</sub> - V<sub>OUT</sub>, when V<sub>OUT</sub> is 100mV below the value of V<sub>OUT</sub> for V<sub>IN</sub> = V<sub>OUT</sub> + 0.5V (only applicable for V<sub>OUT</sub> = 2.5V to 5.0V).
- V<sub>EN</sub> = -0.3V to V<sub>IN</sub>.
- Time needed for V<sub>OUT</sub> to reach 90% of final value.

TYPICAL PERFORMANCE CHARACTERISTICS

$V_{IN} = V_{OUT(NOMINAL)} + 0.5V$  or  $2.5V$  (whichever is greater),  $C_{IN} = 1\mu F$ ,  $C_{OUT} = 1\mu F$ ,  $C_{BP} = 0.01\mu F$ ,  $T_A = +25^\circ C$ , unless otherwise noted.

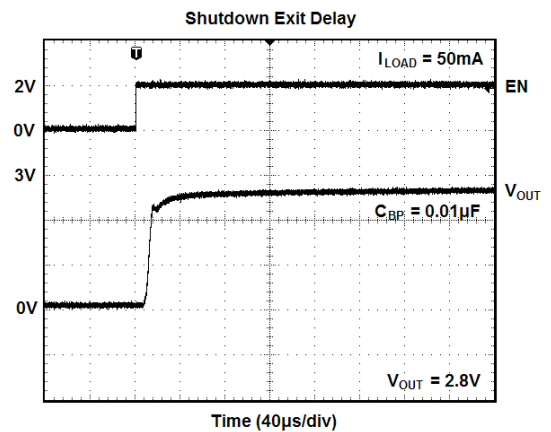
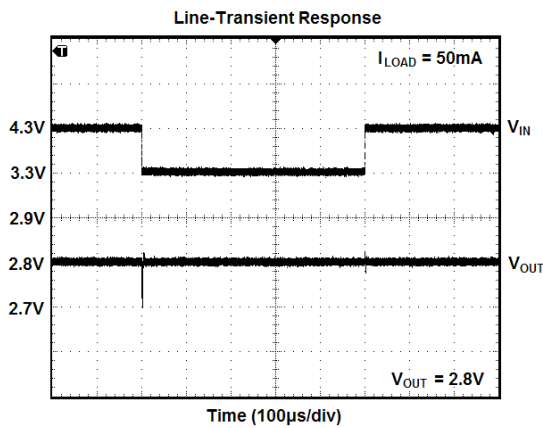
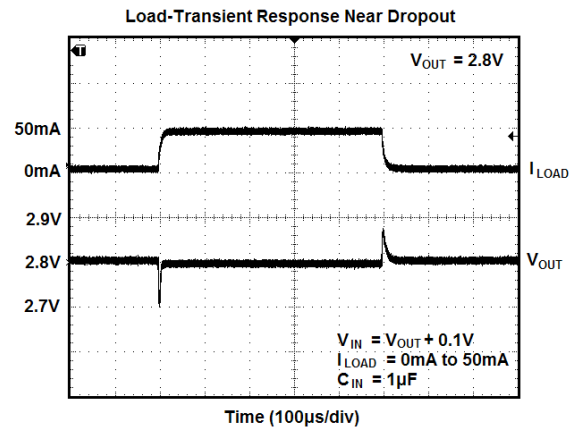
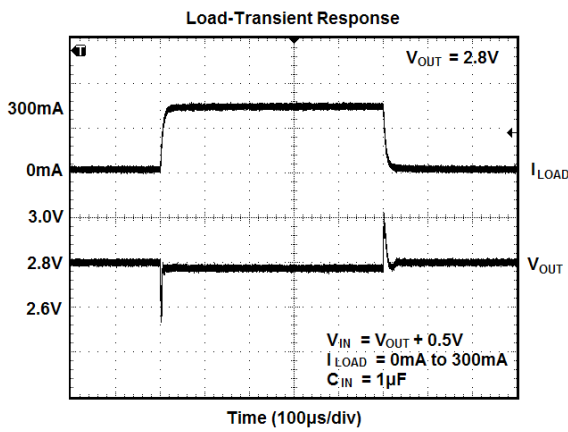
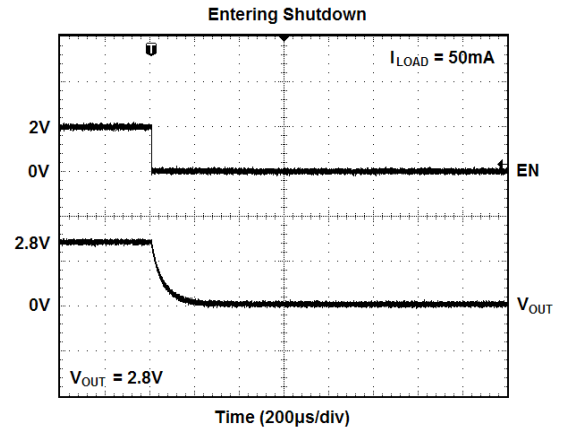
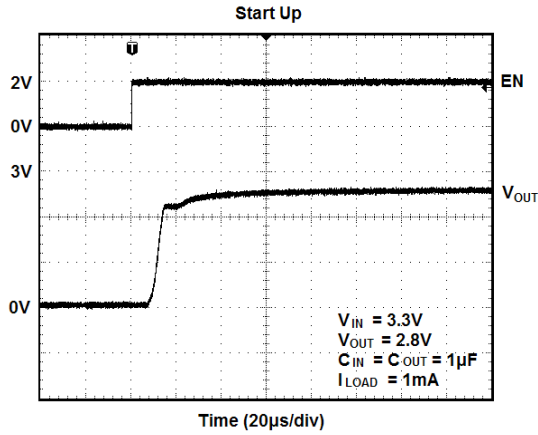

**TYPICAL PERFORMANCE CHARACTERISTICS (continued)**

$V_{IN} = V_{OUT (NOMINAL)} + 0.5V$  or  $2.5V$  (whichever is greater),  $C_{IN} = 1\mu F$ ,  $C_{OUT} = 1\mu F$ ,  $C_{BP} = 0.01\mu F$ ,  $T_A = +25^\circ C$ , unless otherwise noted.

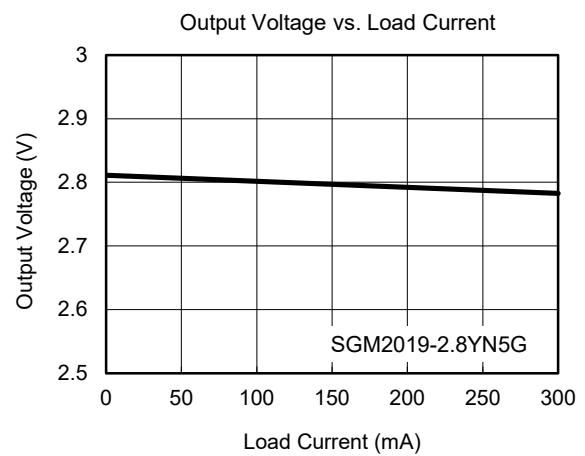
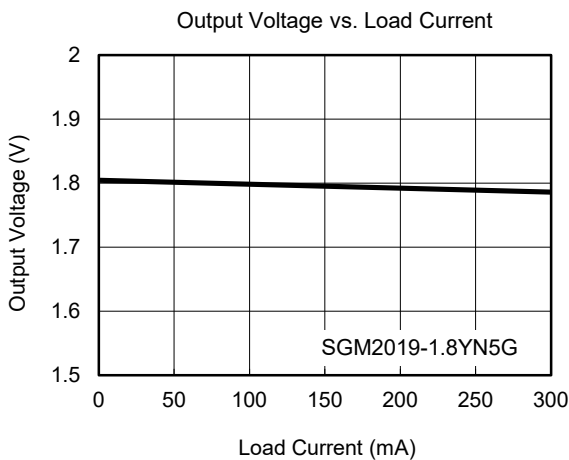
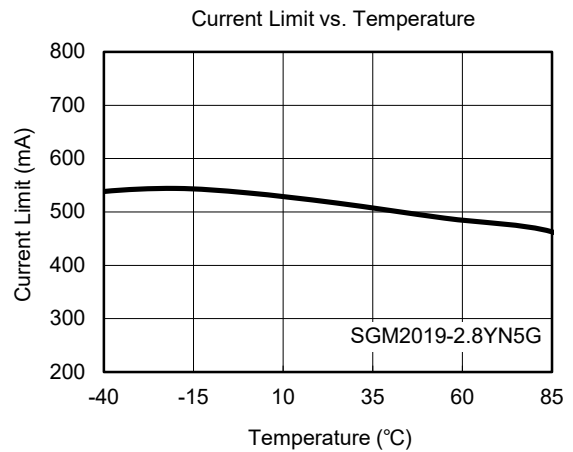
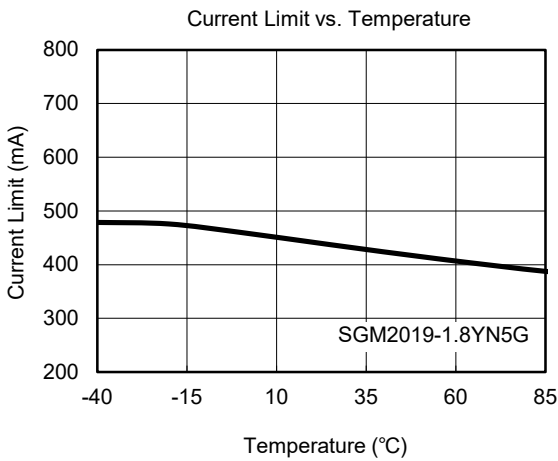
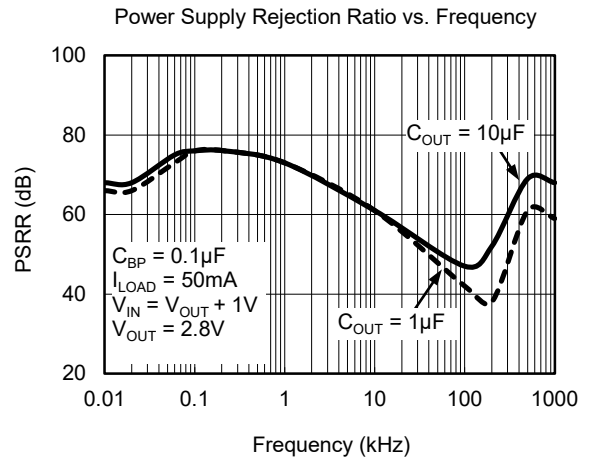
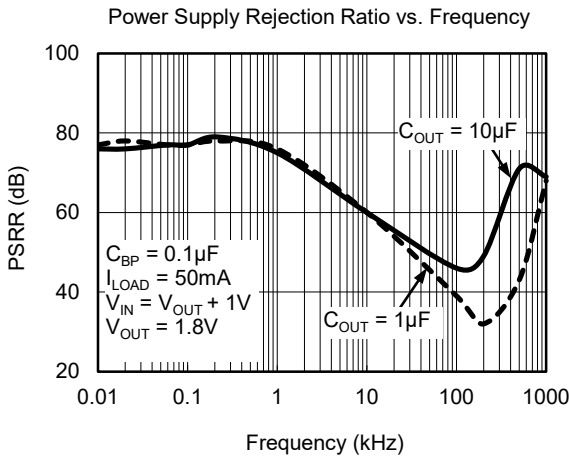

**TYPICAL PERFORMANCE CHARACTERISTICS (continued)**

$V_{IN} = V_{OUT (NOMINAL)} + 0.5V$  or  $2.5V$  (whichever is greater),  $C_{IN} = 1\mu F$ ,  $C_{OUT} = 1\mu F$ ,  $C_{BP} = 0.01\mu F$ ,  $T_A = +25^\circ C$ , unless otherwise noted.

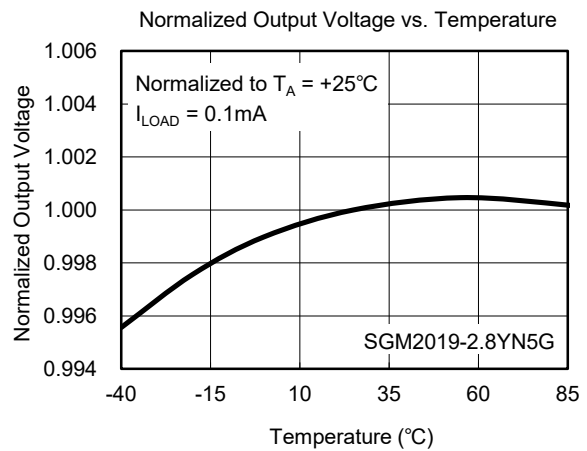
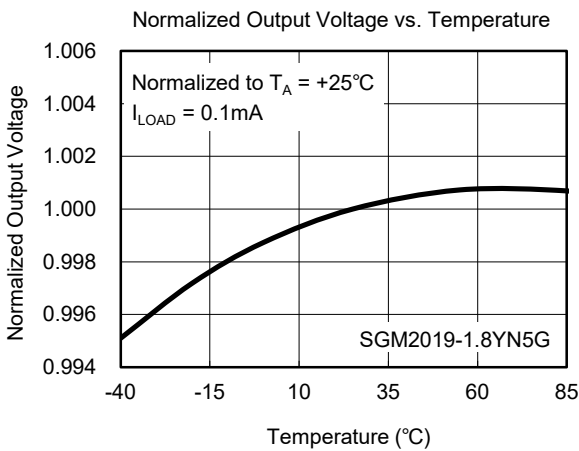
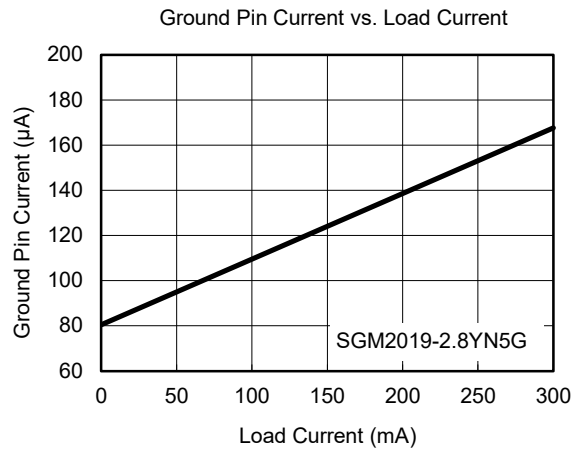
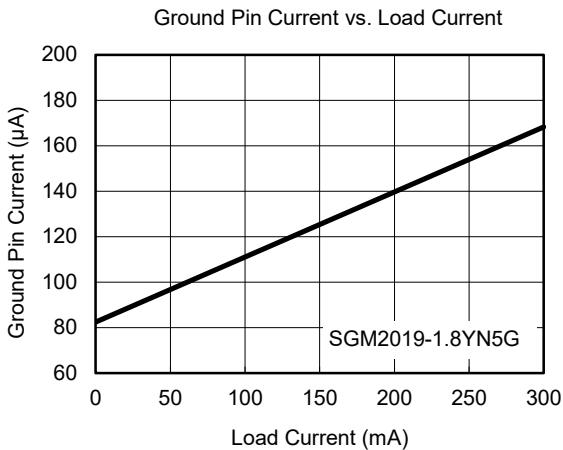
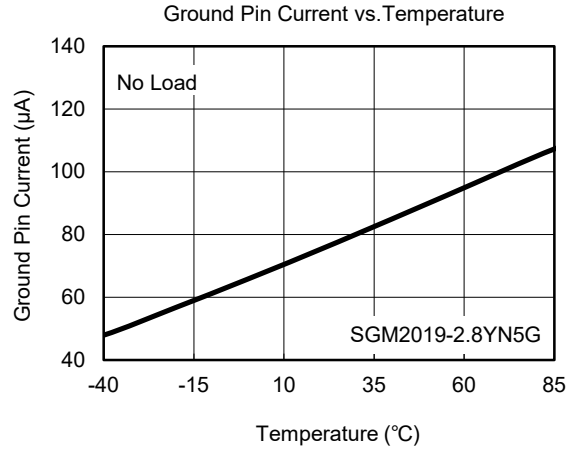
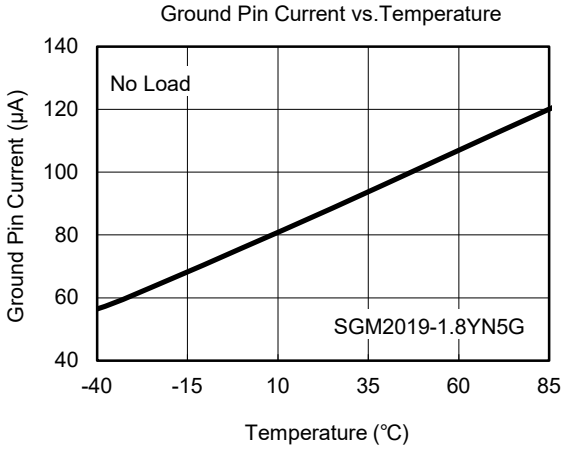



TYPICAL PERFORMANCE CHARACTERISTICS (continued)

$V_{IN} = V_{OUT(NOMINAL)} + 0.5V$  or  $2.5V$  (whichever is greater),  $C_{IN} = 1\mu F$ ,  $C_{OUT} = 1\mu F$ ,  $C_{BP} = 0.01\mu F$ ,  $T_A = +25^\circ C$ , unless otherwise noted.

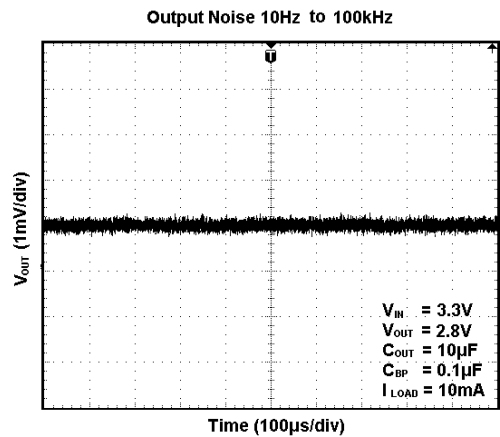
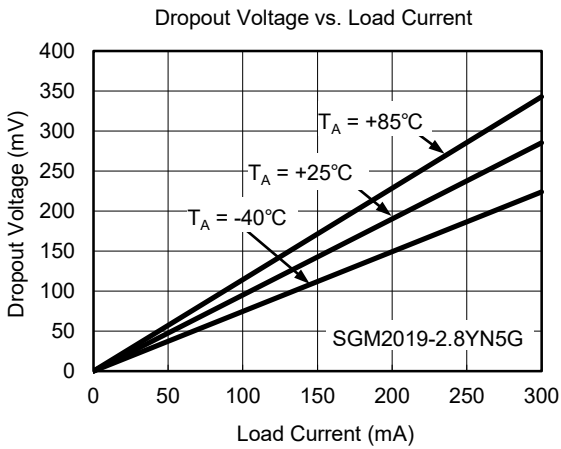
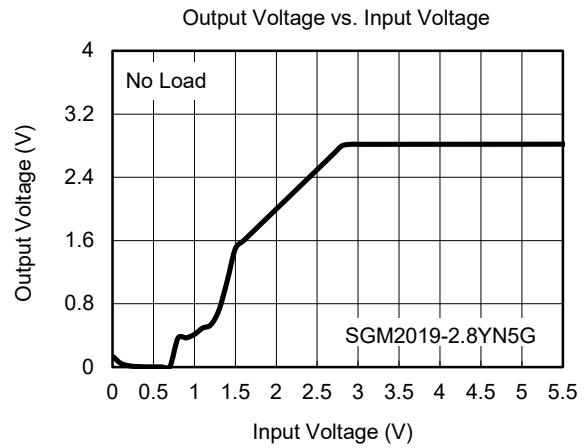
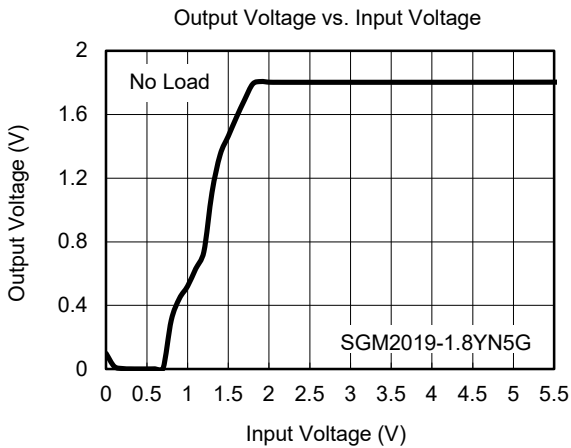
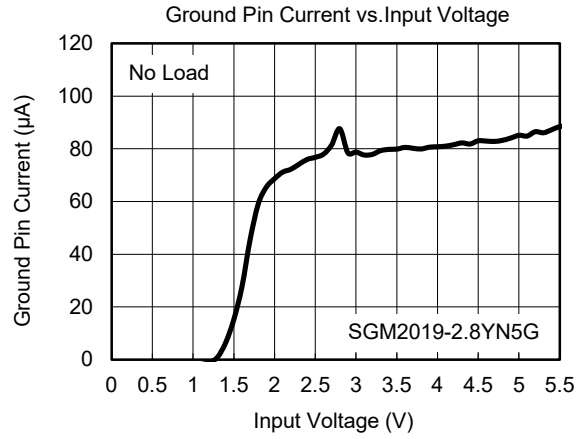
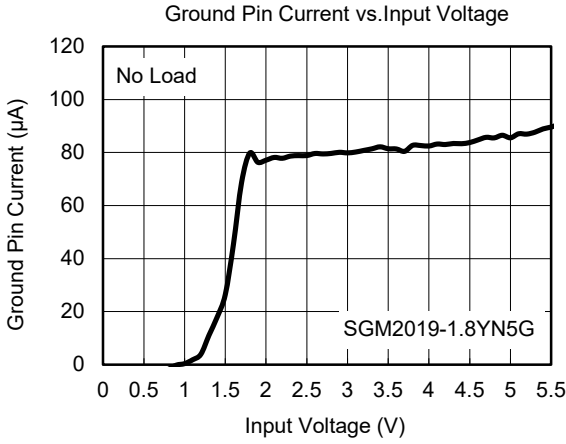

**TYPICAL PERFORMANCE CHARACTERISTICS (continued)**

$V_{IN} = V_{OUT (NOMINAL)} + 0.5V$  or  $2.5V$  (whichever is greater),  $C_{IN} = 1\mu F$ ,  $C_{OUT} = 1\mu F$ ,  $C_{BP} = 0.01\mu F$ ,  $T_A = +25^\circ C$ , unless otherwise noted.

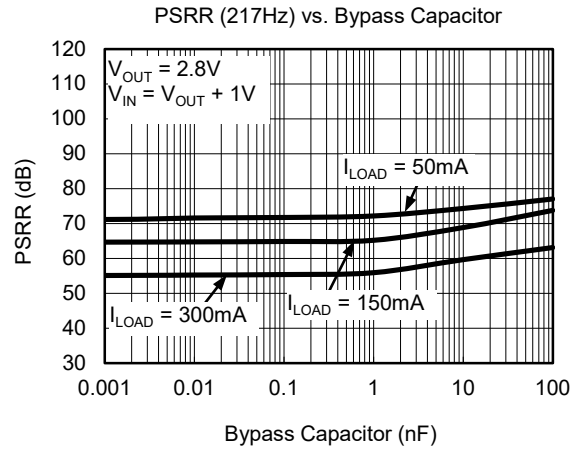
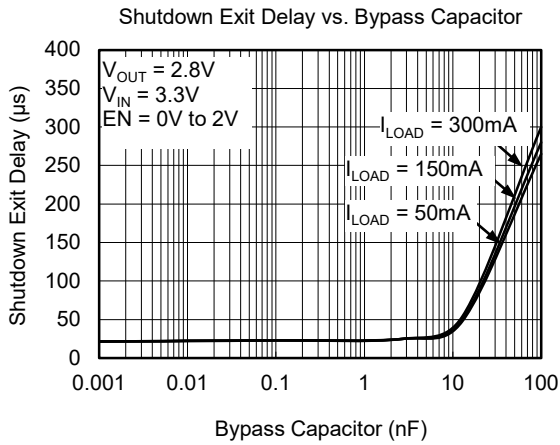

TYPICAL APPLICATION CIRCUITS

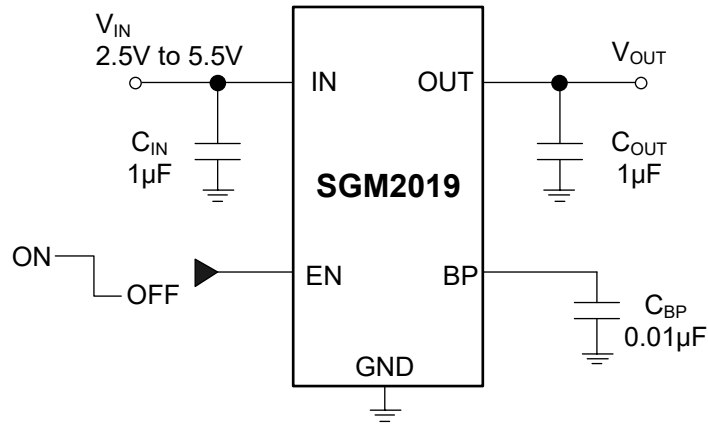

C <sub>BP</sub> (nF)	Shutdown Exit Delay (µs) V <sub>OUT</sub> = 2.8V, V <sub>IN</sub> = 3.3V, EN = 0V to 2V			PSRR (dB) at 217Hz V <sub>OUT</sub> = 2.8V, V <sub>IN</sub> = V <sub>OUT</sub> + 1V		
	I <sub>LOAD</sub> = 50mA	I <sub>LOAD</sub> = 150mA	I <sub>LOAD</sub> = 300mA	I <sub>LOAD</sub> = 50mA	I <sub>LOAD</sub> = 150mA	I <sub>LOAD</sub> = 300mA
None	21.5	21.5	21	71.1	64.4	55.0
0.001	21.5	21.5	22	71.1	64.6	55.1
0.01	22	22.5	22.5	71.6	64.7	55.2
0.1	22.5	23	23	71.7	64.8	55.4
1	25	27	28.5	72.1	65.2	55.9
10	30	35	39	74.3	68.8	59.6
100	265	280	300	77.0	73.7	63.1

TYPICAL APPLICATION CIRCUITS (continued)

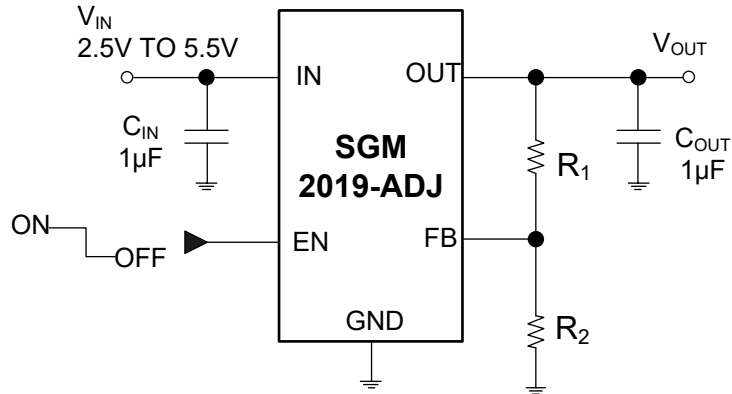

Standard 1% Resistor Values for Common Output Voltages of Adjustable Voltage Version

V <sub>OUT</sub> (V)	R <sub>1</sub> (kΩ)	R <sub>2</sub> (kΩ)
1.2	0	63.4
1.5	10.5	42.2
1.8	34	63.4
2.8	84.5	63.4
3.0	63.4	42.2
3.3	73.2	42.2
3.6	84.5	42.2
4.2	105	42.2

NOTE:  $V_{OUT} = (R_1 + R_2) / R_2 \times 1.207$

## APPLICATION INFORMATION

The SGM2019 is a low power and low dropout LDO and provides 300mA output current. These features make the SGM2019 useful in a variety of applications. The SGM2019 provides protection functions for output overload and overheating.

### Input Capacitor Selection ( $C_{IN}$ )

The input decoupling capacitor is necessary to be connected as close as possible to the IN pin for ensuring the device stability. 1 $\mu$ F or larger X7R or X5R ceramic capacitor is selected to get good dynamic performance.

When  $V_{IN}$  is required to provide large current instantaneously, a large effective input capacitor is required. Multiple input capacitors can limit the input tracking inductance. Adding more input capacitors is available to restrict the ringing and to keep it below the device absolute maximum ratings.

### Output Capacitor Selection ( $C_{OUT}$ )

The output decoupling capacitor should be located as close as possible to the OUT pin. 1 $\mu$ F or larger X7R or X5R ceramic capacitor is selected to get good dynamic performance.

### Enable Control

The SGM2019 uses the EN pin to enable/disable its device.

When the EN pin voltage is lower than 0.3V, the device is in shutdown state. There is no current flowing from IN pin to OUT pin.

When the EN pin voltage is higher than 1.5V, the device is in active state. The output voltage is regulated to expected value.

### Output Current Limit

When overload events happen, the output current is internally limited to 500mA (TYP).

### Thermal Shutdown

The SGM2019 can detect the temperature of die. When the die temperature exceeds the threshold value of thermal shutdown, the SGM2019 will be in shutdown state and it will remain in this state until the die temperature decreases to +135°C.

### Layout Guidelines

To get good PSRR, low output noise and high transient response performance, the input and output bypass capacitors must be placed as close as possible to the IN pin and OUT pin separately.

## REVISION HISTORY

NOTE: Page numbers for previous revisions may differ from page numbers in the current version.

	Page
<b>MAY 2023 – REV.C.1 to REV.C.2</b>	
Updated Package Outline Dimensions.....	14
<b>APRIL 2016 – REV.C to REV.C.1</b>	
Changed the Normalized Output Voltage vs. Temperature curves.....	8
<b>MAY 2012 – REV.B.4 to REV.C</b>	
Added SGM2019-2.6YC5G version.....	All

PACKAGE OUTLINE DIMENSIONS

SC70-5

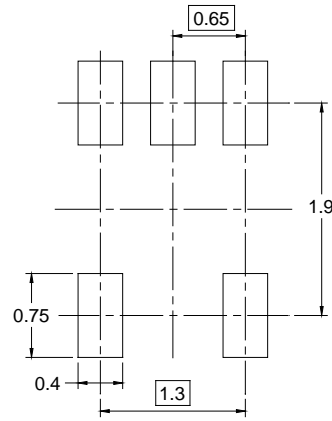
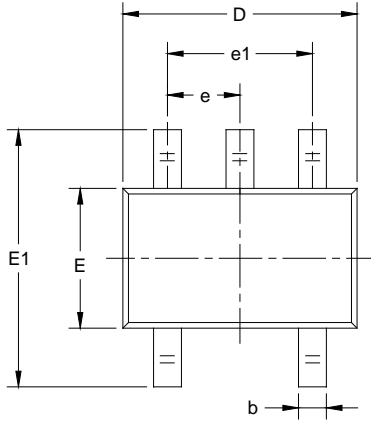

RECOMMENDED LAND PATTERN (Unit: mm)

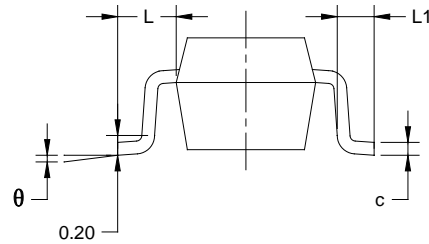
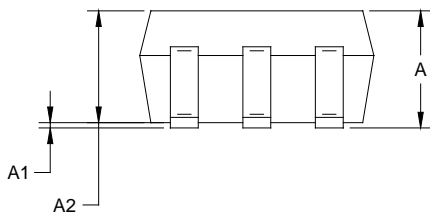

Symbol	Dimensions In Millimeters		Dimensions In Inches	
	MIN	MAX	MIN	MAX
A	0.800	1.100	0.031	0.043
A1	0.000	0.100	0.000	0.004
A2	0.800	1.000	0.031	0.039
b	0.150	0.350	0.006	0.014
c	0.080	0.220	0.003	0.009
D	2.000	2.200	0.079	0.087
E	1.150	1.350	0.045	0.053
E1	2.150	2.450	0.085	0.096
e	0.65 TYP		0.026 TYP	
e1	1.300 BSC		0.051 BSC	
L	0.525 REF		0.021 REF	
L1	0.260	0.460	0.010	0.018
$\theta$	0°	8°	0°	8°

NOTES:

1. Body dimensions do not include mode flash or protrusion.
2. This drawing is subject to change without notice.

## PACKAGE OUTLINE DIMENSIONS

### SOT-23-5

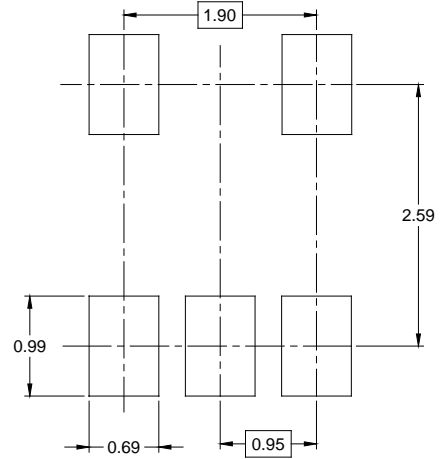
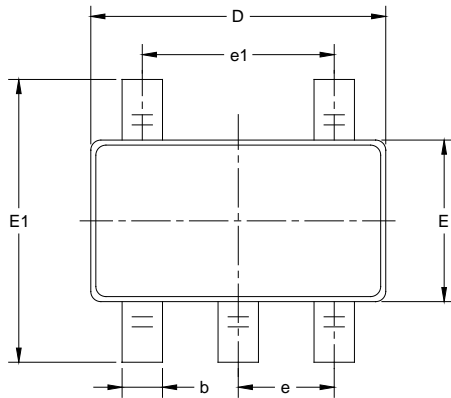

RECOMMENDED LAND PATTERN (Unit: mm)

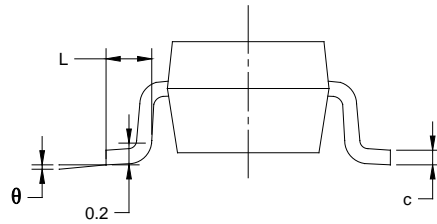
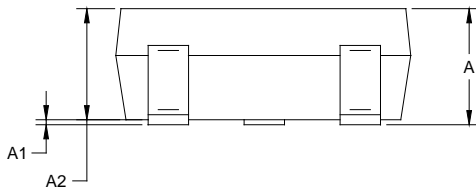

Symbol	Dimensions In Millimeters		Dimensions In Inches	
	MIN	MAX	MIN	MAX
A	1.050	1.250	0.041	0.049
A1	0.000	0.100	0.000	0.004
A2	1.050	1.150	0.041	0.045
b	0.300	0.500	0.012	0.020
c	0.100	0.200	0.004	0.008
D	2.820	3.020	0.111	0.119
E	1.500	1.700	0.059	0.067
E1	2.650	2.950	0.104	0.116
e	0.950 BSC		0.037 BSC	
e1	1.900 BSC		0.075 BSC	
L	0.300	0.600	0.012	0.024
$\theta$	0°	8°	0°	8°

NOTES:

1. Body dimensions do not include mode flash or protrusion.
2. This drawing is subject to change without notice.

# PACKAGE INFORMATION

## TAPE AND REEL INFORMATION

### REEL DIMENSIONS



### TAPE DIMENSIONS



NOTE: The picture is only for reference. Please make the object as the standard.

### KEY PARAMETER LIST OF TAPE AND REEL

Package Type	Reel Diameter	Reel Width W1 (mm)	A0 (mm)	B0 (mm)	K0 (mm)	P0 (mm)	P1 (mm)	P2 (mm)	W (mm)	Pin1 Quadrant
SC70-5	7"	9.5	2.40	2.50	1.20	4.0	4.0	2.0	8.0	Q3
SOT-23-5	7"	9.5	3.20	3.20	1.40	4.0	4.0	2.0	8.0	Q3

DD0001



# PACKAGE INFORMATION

## CARTON BOX DIMENSIONS



NOTE: The picture is only for reference. Please make the object as the standard.

## KEY PARAMETER LIST OF CARTON BOX

Reel Type	Length (mm)	Width (mm)	Height (mm)	Pizza/Carton
7" (Option)	368	227	224	8
7"	442	410	224	18

DD0002