

GENERAL DESCRIPTION

The SGM2058 is a negative output charge pump which has an inside adjustable regulator. The input voltage range is from 2.3V to 5.5V and the unregulated output equals to $-V_{IN}$. For the regulated output of the SGM2058, it equals to $-V_{CTL}$ and the range is from 0V to $-V_{IN}$.

The inrush current of the SGM2058 can be decreased by the internal soft-start circuit. For application case, four ceramic capacitors and no inductor are required, and it can be used for supplying optical modules, bias of RF amplifiers and sensors.

The SGM2058 is available in a Green TQFN-1.8×1.4-10L package. It operates over an operating temperature range of -40°C to $+125^{\circ}\text{C}$.

FEATURES

- **Input Voltage Range: 2.3V to 5.5V**
- **Dual Outputs:**
 - ◆ V_{OUT1} : $-V_{IN}$
(Unregulated Negative Charge Pump Output)
 - ◆ V_{OUT2} : $-V_{CTL}$ between 0V and $-V_{IN}$
(Regulated Output)
- **Output Current Limit: 265mA (TYP)**
- **Stable with Small Case Size Ceramic Capacitors**
- **Thermal Shutdown Protection**
- **No Inrush Current during Start-Up**
- **-40°C to $+125^{\circ}\text{C}$ Operating Temperature Range**
- **Available in a Green TQFN-1.8×1.4-10L Package**

APPLICATIONS

- Optical Applications
- Biasing of the Amplifier for RF
- Supplying Sensors in Portable Devices

TYPICAL APPLICATION

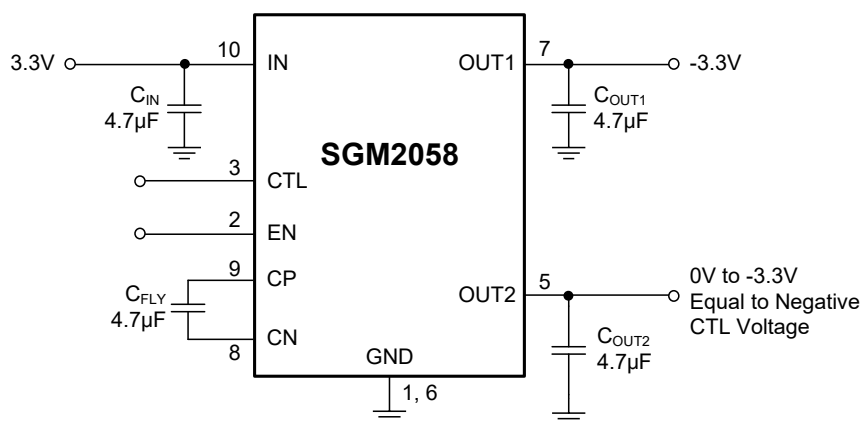

Figure 1. Typical Application Circuit

PACKAGE/ORDERING INFORMATION

MODEL	PACKAGE DESCRIPTION	SPECIFIED TEMPERATURE RANGE	ORDERING NUMBER	PACKAGE MARKING	PACKING OPTION
SGM2058	TQFN-1.8x1.4-10L	-40°C to +125°C	SGM2058XWQ10G/TR	S3I XXX	Tape and Reel, 3000

MARKING INFORMATION

NOTE: XXX = Date Code and Trace Code.

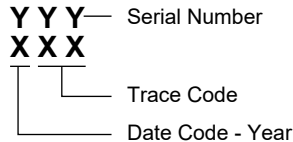

Green (RoHS & HSF): SG Micro Corp defines "Green" to mean Pb-Free (RoHS compatible) and free of halogen substances. If you have additional comments or questions, please contact your SGMICRO representative directly.

ABSOLUTE MAXIMUM RATINGS

- IN to GND -0.3V to 6V
- CP to GND -0.3V to (V_{IN} + 0.3V)
- CN, OUT2 to GND (V_{OUT1} - 0.3V) to 0.3V
- OUT1 to GND -6V to 0.3V
- All Other Pins to GND -0.3V to 6V
- Package Thermal Resistance
- TQFN-1.8x1.4-10L, θ_{JA} 166°C/W
- Junction Temperature +150°C
- Storage Temperature Range -65°C to +150°C
- Lead Temperature (Soldering, 10s) +260°C
- ESD Susceptibility
- HBM 4000V
- CDM 1000V

RECOMMENDED OPERATING CONDITIONS

- Supply Voltage Range 2.3V to 5.5V
- Input Effective Capacitance, C_{IN} 1μF to 10μF
- Fly Effective Capacitance, C_{FLY} 4.7μF (TYP)
- OUT1 Effective Capacitance, C_{OUT1} 1μF (MIN)
- OUT2 Effective Capacitance, C_{OUT2} 1μF to 10μF
- Operating Junction Temperature Range -40°C to +125°C

OVERSTRESS CAUTION

Stresses beyond those listed in Absolute Maximum Ratings may cause permanent damage to the device. Exposure to absolute maximum rating conditions for extended periods may affect reliability. Functional operation of the device at any conditions beyond those indicated in the Recommended Operating Conditions section is not implied.

ESD SENSITIVITY CAUTION

This integrated circuit can be damaged if ESD protections are not considered carefully. SGMICRO recommends that all integrated circuits be handled with appropriate precautions. Failure to observe proper handling and installation procedures can cause damage. ESD damage can range from subtle performance degradation to complete device failure. Precision integrated circuits may be more susceptible to damage because even small parametric changes could cause the device not to meet the published specifications.

DISCLAIMER

SG Micro Corp reserves the right to make any change in circuit design, or specifications without prior notice.

PIN CONFIGURATION

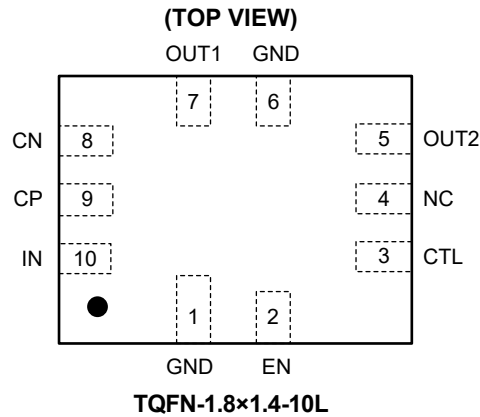

PIN DESCRIPTION

PIN	NAME	FUNCTION
1, 6	GND	Ground.
2	EN	Enable Pin. Drive EN high to turn on the device. Drive EN low to turn off the device. The EN pin has an internal pull-down resistance to ensure that the device is turned off when the EN pin is floating.
3	CTL	Analog Input Voltage Pin. $V_{OUT2} = -V_{CTL}$.
4	NC	Recommend connecting this pin to GND.
5	OUT2	Regulator Output Pin. It is recommended to use an output capacitor (C_{OUT2}) with effective capacitance in the range of $1\mu\text{F}$ to $10\mu\text{F}$.
7	OUT1	Negative Charge Pump Output Pin. It is recommended to use an output capacitor (C_{OUT1}) with effective capacitance in the range of $1\mu\text{F}$ to $10\mu\text{F}$.
8	CN	Negative Connection for the Charge Pump Flying Capacitor.
9	CP	Positive Connection for the Charge Pump Flying Capacitor.
10	IN	Input Voltage Supply Pin. Decoupling capacitor should be added for this power supply.

ELECTRICAL CHARACTERISTICS

(V_{IN} = 3.3V, C_{IN} = C_{FLY} = C_{OUT1} = C_{OUT2} = 4.7μF, T_J = -40°C to +125°C, typical values are at T_J = +25°C, unless otherwise noted.)

PARAMETER	SYMBOL	CONDITIONS	MIN	TYP	MAX	UNITS	
Input Voltage Range	V _{IN}		2.3		5.5	V	
Input Under-Voltage Lockout Threshold	V _{IN_UVLO}	V _{IN} rising		2.2	2.3	V	
UVLO Threshold Hysteresis	V _{IN_HYS}		60	90	120	mV	
Shutdown Current	I _{SHDN}	V _{EN} = 0V		0.1	1	μA	
Quiescent Current	I _Q	V _{EN} = 2V, force V _{OUT1} = -3.4V, no switching	T _J = +25°C		170	210	μA
			T _J = -40°C to +125°C		170	230	
Charge Pump MOSFET On-Resistance	R _{ON}			0.28		Ω	
Negative Linear Regulator							
Output Current Limit	I _{LIMIT}	V _{IN} = 3.3V, V _{OUT2} = -2.5V		265	360	mA	
Output Voltage		V _{CTL} = 2.5V, I _{OUT2} = 10mA	T _J = +25°C		-2.532	-2.507	V
			T _J = -40°C to +125°C		-2.544	-2.507	
Output Offset Voltage		I _{OUT2} = 10mA	-22		22	mV	
Dropout Voltage	V _{DROP}	V _{IN} = 2.5V, I _{OUT2} = 60mA	15		66	mV	
		V _{IN} = 3.3V, I _{OUT2} = 60mA	5		58		
Load Regulation	ΔV _{OUT}	V _{OUT1} = -3.3V, V _{CTL} = 1V, I _{OUT2} = 0 to 150mA		0.004	0.015	%/mA	
Power Supply Rejection Ratio	PSRR	C _{OUT1} = 1μF, C _{OUT2} = 1μF, I _{OUT2} = 10mA	f = 100Hz		70		dB
			f = 50kHz		30		
Soft-Start Slew Rate				10		V/ms	
EN Turn-On Delay			80		255	μs	
EN Input Threshold	V _{IL}	Logic low			0.4	V	
	V _{IH}	Logic high	1.2				
Output Discharge Resistance	R _{DIS1}	V _{EN} = 0V, OUT1 rail		130		Ω	
	R _{DIS2}	V _{EN} = 0V, OUT2 rail		125			
EN Input Current	I _{EN}	V _{EN} = 2V	1.2	1.8	2.4	μA	
		V _{EN} = 0V		0			
Thermal Shutdown Temperature	T _{SHDN}			160		°C	
Thermal Shutdown Hysteresis	ΔT _{SHDN}			20		°C	
System Level							
OUT1 Pin Voltage				-1×		V _{IN}	
Output Ripple	V _{RIPPLE_OUT1}	V _{IN} = 3.3V, V _{OUT1} = -3.3V, C _{FLY} = C _{OUT1} = 4.7μF, I _{OUT1} = 60mA		7		mV	
	V _{RIPPLE_OUT2}	V _{IN} = 3.3V, V _{OUT2} = 2.5V, C _{OUT2} = 1μF, I _{OUT2} = 60mA		2			
	V _{RIPPLE_OUT2}	V _{IN} = 3.3V, V _{OUT2} = 2.5V, C _{OUT2} = 4.7μF, I _{OUT2} = 60mA		2			

TYPICAL PERFORMANCE CHARACTERISTICS

$T_J = +25^\circ\text{C}$, $V_{IN} = 3.3\text{V}$, $V_{OUT1} = -3.3\text{V}$, $V_{OUT2} = -1\text{V}$, $C_{IN} = C_{FLY} = C_{OUT1} = C_{OUT2} = 4.7\mu\text{F}$, unless otherwise noted.

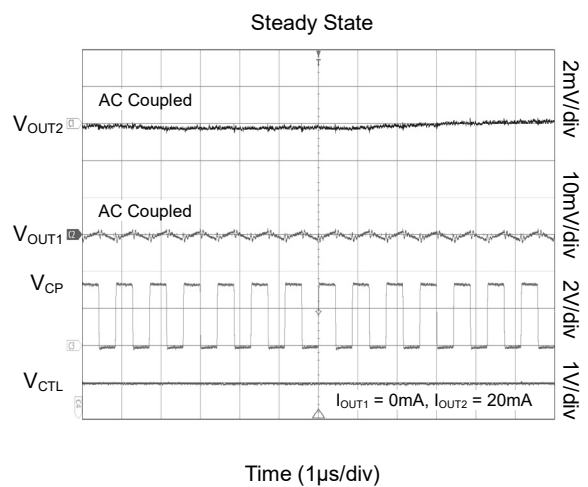
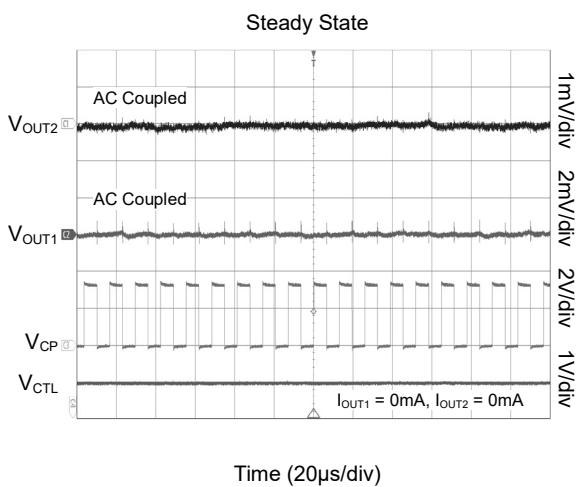
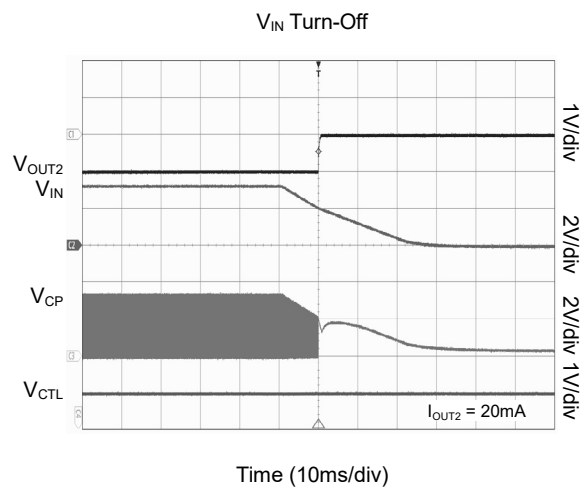
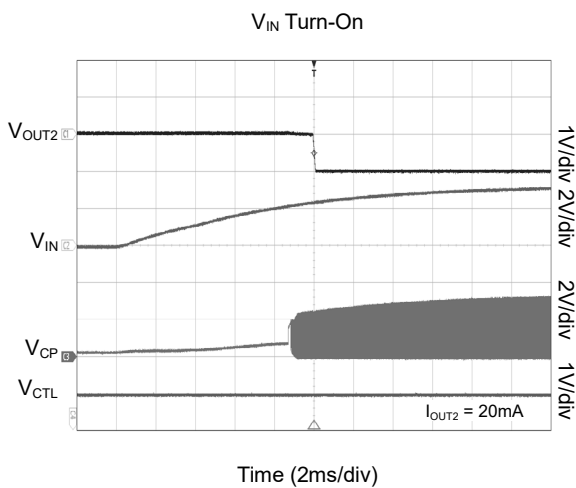
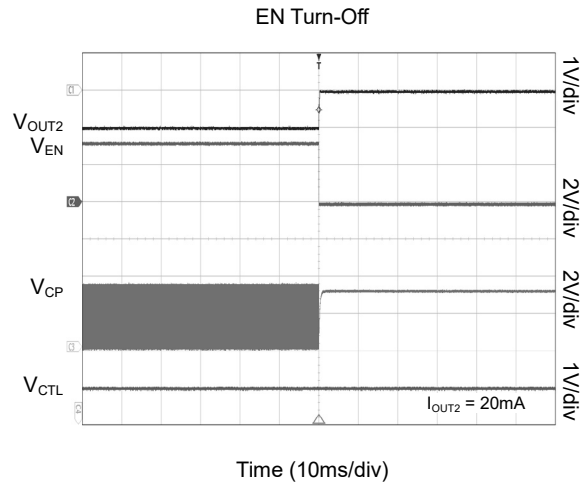
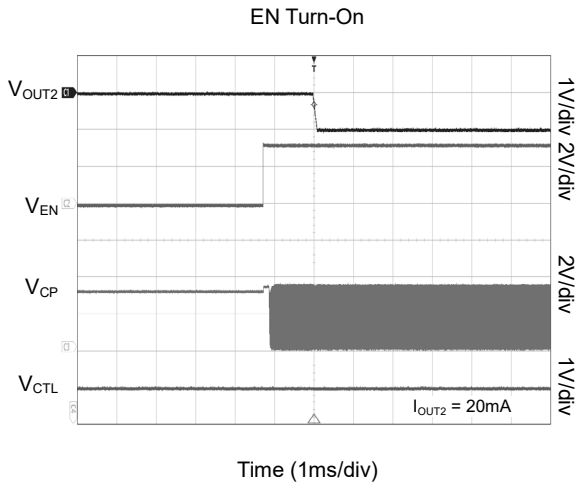

TYPICAL PERFORMANCE CHARACTERISTICS (continued)

$T_J = +25^\circ\text{C}$, $V_{IN} = 3.3\text{V}$, $V_{OUT1} = -3.3\text{V}$, $V_{OUT2} = -1\text{V}$, $C_{IN} = C_{FLY} = C_{OUT1} = C_{OUT2} = 4.7\mu\text{F}$, unless otherwise noted.

Steady State

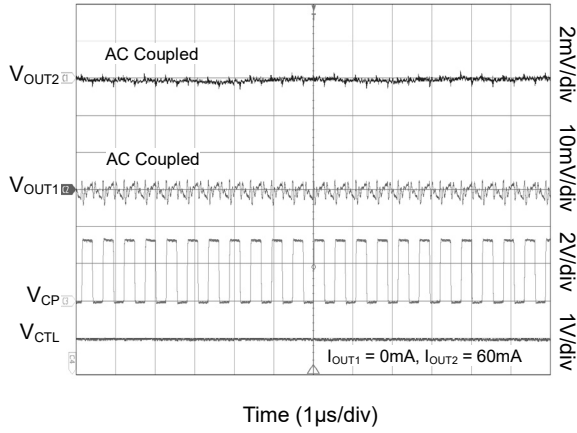

Load Capability

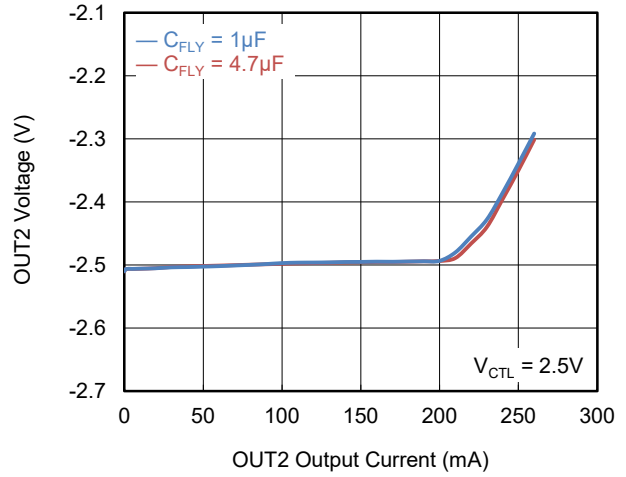

OUT2 Dropout Voltage vs. Temperature

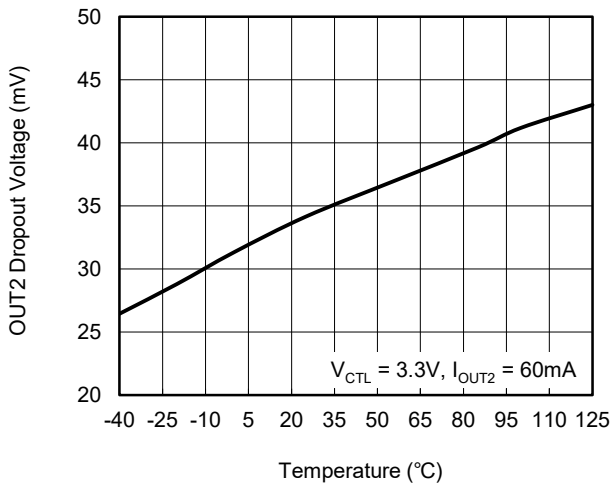

OUT2 Voltage vs. Temperature

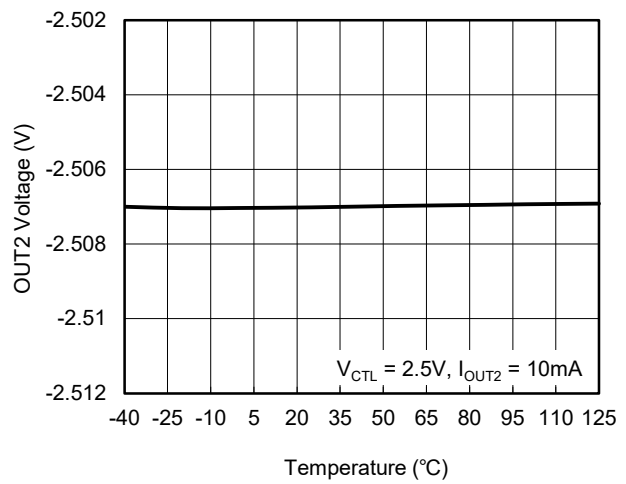

OUT2 Current Limit vs. Temperature

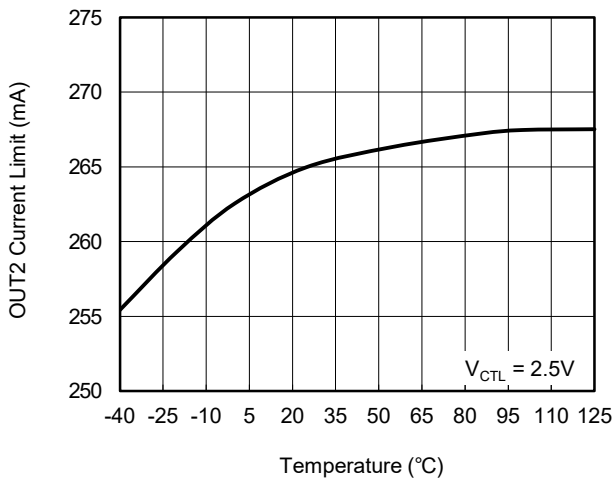

Negative Linear Regulator Load Regulation

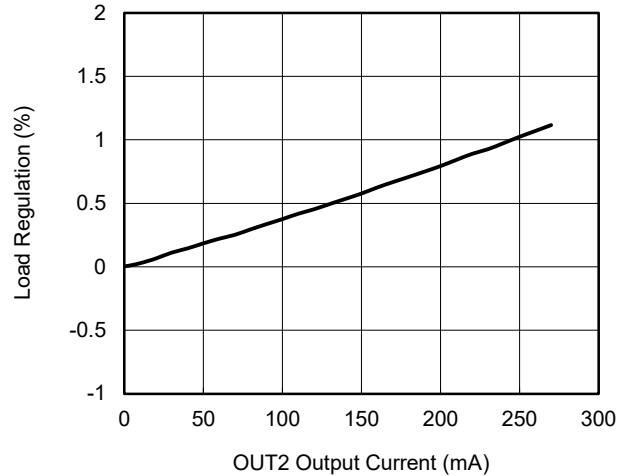

FUNCTIONAL BLOCK DIAGRAM

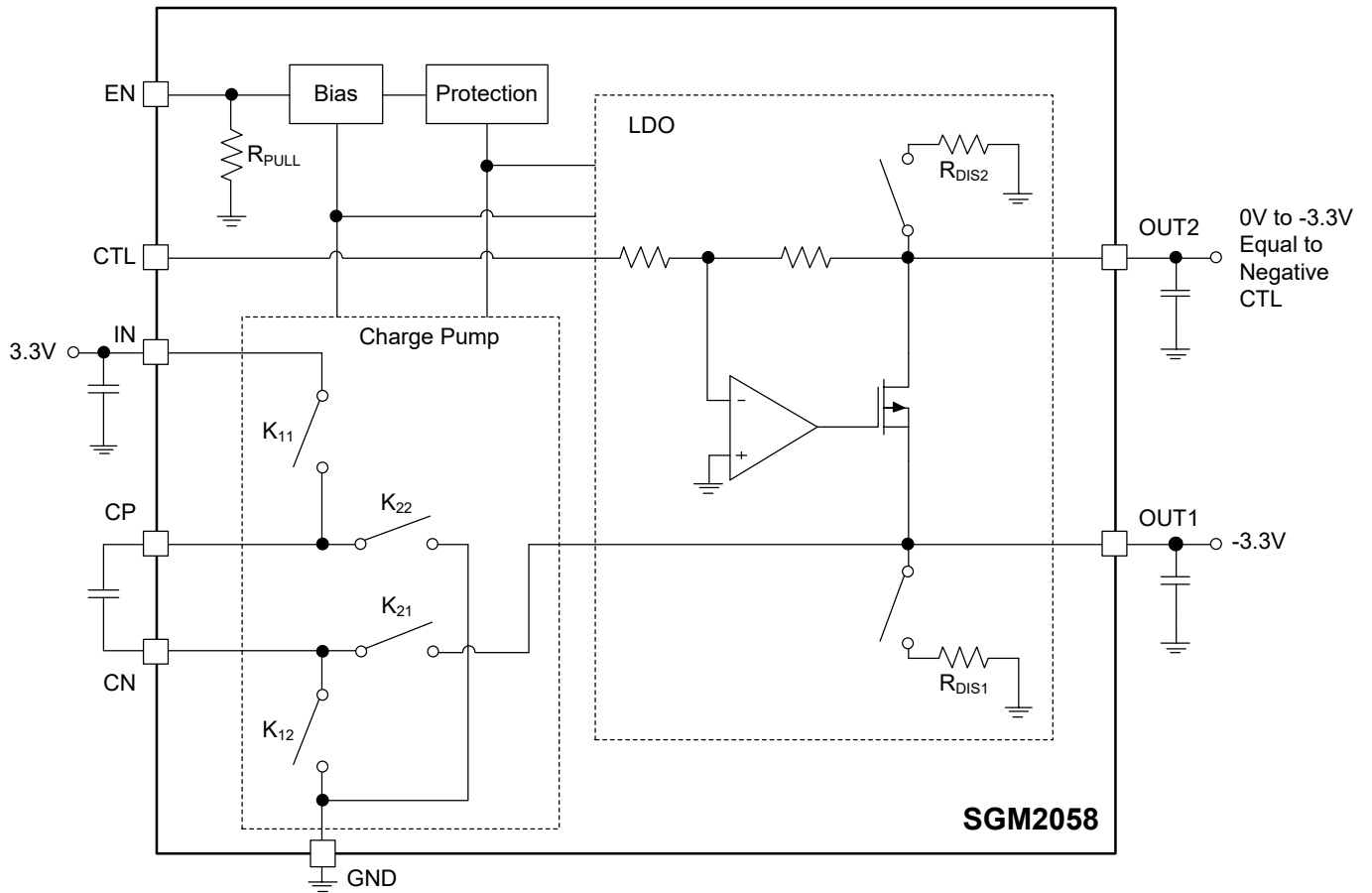

Figure 2. Functional Block Diagram

APPLICATION INFORMATION

The SGM2058 is a negative output charge pump which has an inside adjustable regulator. The input voltage range is from 2.3V to 5.5V and the unregulated output equals to $-V_{IN}$. For the regulated output of the SGM2058, it equals to $-V_{CTL}$ and the range is from 0V to $-V_{IN}$.

The inrush current of the SGM2058 can be decreased by the internal soft-start circuit.

Negative Charge Pump

The technology of getting $-V_{IN}$ (unregulated output) is by using the switched capacitors. Use an integrated oscillator to create a switching signal for driving the charge pump. The switching frequency of the oscillator is from 80kHz to 1875kHz (TYP). Also, the switching frequency can be changed with the dropout voltage between V_{IN} and V_{OUT1} . When heavy load occurs, this frequency will increase to compensate the output ripple.

The SGM2058 will assume that there is an over-current condition if $V_{OUT1} < V_{IN}/2$, so that the switching frequency of oscillator will be forced at 80kHz for fold-back.

Negative Linear Regulator

The negative linear regulator V_{OUT2} is integrated with the charge pump which powers it. For the properties of the internal regulator, the dropout voltage, quiescent supply and the output noise are extremely low. Also, the range is from 0V to V_{OUT1} .

V_{OUT2} is controlled by the feedback loop of the linear regulator and the relationship between V_{CTL} and V_{OUT2} is $V_{CTL} = -V_{OUT2}$. Also, the regulator provides a convenient interface for DAC, and the output of the SGM2058 can be driven by the input of DAC directly.

The output ripple of the negative linear regulator is extremely low because of the special design of Power Supply Rejection Ratio for its charge pump.

Output Voltage Setting

The absolute output voltage of the internal regulator is equal to V_{CTL} , which means that $V_{OUT2} = -V_{CTL}$. The analog input pin (CTL) can be connected directly to the output of DAC. The application circuit is shown as below:

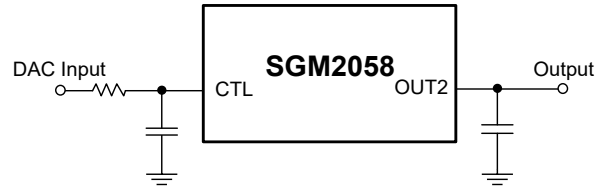

Figure 3. Output Voltage Setting

Enable Operation

The SGM2058 uses the EN pin to enable/disable the device and to deactivate/activate the output automatic discharge function.

When the EN pin voltage is lower than 0.4V, the device is in shutdown state. There is no current flowing from IN to OUT pins. In this state, the automatic discharge transistor is active to discharge the output voltage through R_{DIS1} (typically 130 Ω) and R_{DIS2} (typically 125 Ω).

When the EN pin voltage is higher than 1.2V, the device is in active state. The output voltage is regulated to the expected value and the automatic discharge transistor is turned off.

Equivalent Output Resistance

The charge pump frequency and fly capacitor determine the output resistance of the SGM2058 as shown in the following equation:

$$R_o = \frac{1}{f \times C_{FLY}} + 8 \times R_{ON} \quad (1)$$

where:

R_{ON} is the on-resistance of each charge pump MOSFET.

The output current (I_o) and resistance (R_o) determine the charge pump output V_{OUT1} as shown in the following equation:

$$V_{OUT1} = -(V_{IN} - I_o \times R_o) \quad (2)$$

Soft-Start

Soft-start circuitry is integrated into the IC, which supplies the controlled slew rate for the output voltage of the linear regulator to prevent the SGM2058 from overshoot at the instant of start-up. The typical ramp-up time is within 500 μ s (TYP). For the typically value of slew-rate, it can reach 10V/ms (TYP).

APPLICATION INFORMATION (continued)**Load Capability**

The summation of I_{OUT1} and I_{OUT2} should be less than 265mA (TYP) because of the limitation of the load capability. Also, the changes of load capability are associated with output and fly capacitors. If the selected capacitors are smaller, the load capability will be decreased.

Input Capacitor Selection (C_{IN})

The input decoupling capacitor is necessary to be connected as close as possible to the IN pin. A 1 μ F to 10 μ F dielectric X7R or X5R ceramic capacitor is selected to get good dynamic performance.

Output Capacitor Selection (C_{OUT1} , C_{OUT2})

The output decoupling capacitors should be located as close as possible to the OUT pins. A 1 μ F capacitor for C_{OUT1} and a 1 μ F to 10 μ F capacitor for C_{OUT2} are selected to get good dynamic performance. For ceramic capacitor, temperature, DC bias and package size will change the effective capacitance, so enough margins of C_{OUT1} and C_{OUT2} must be considered in design.

Fly Capacitor Selection (C_{FLY})

According to Equation 1, the output voltage and resistance will be affected by the capacitance of the C_{FLY} . If the users prepare to use the charge pump in heavy load condition, it is recommended to set a larger

capacitor than normal to handle this situation. For application, the C_{FLY} should be closed to both C_{IN} and C_{OUT1} , and it is a good choice to set the capacitance of these three capacitors equally.

Thermal Shutdown Protection

The SGM2058 can detect the temperature of die. When the die temperature exceeds the threshold value of thermal shutdown, the SGM2058 will be in shutdown state and it will remain in this state until the die temperature decreases to +140°C (TYP).

Under-Voltage Lockout (UVLO)

The UVLO circuit monitors the input voltage to prevent the device from turning on before V_{IN} rises above the V_{UVLO} threshold. The UVLO circuit responds quickly to glitches on the IN pin and attempts to disable the output of the device if either of these rails collapses. The local input capacitance prevents severe brownouts in most applications.

PCB Layout

To obtain better performance of the SGM2058, the input and output bypass capacitors must be placed as close as possible to the IN pin and OUTx pins separately. There are four high-current paths which are GND, IN, CP and CN. The short and wide traces must be used to connect these pins.

REVISION HISTORY

NOTE: Page numbers for previous revisions may differ from page numbers in the current version.

MARCH 2023 – REV.A to REV.A.1

	Page
Updated Functional Block Diagram.....	7

Changes from Original (MARCH 2022) to REV.A

	Page
Changed from product preview to production data.....	All

PACKAGE OUTLINE DIMENSIONS

TQFN-1.8×1.4-10L

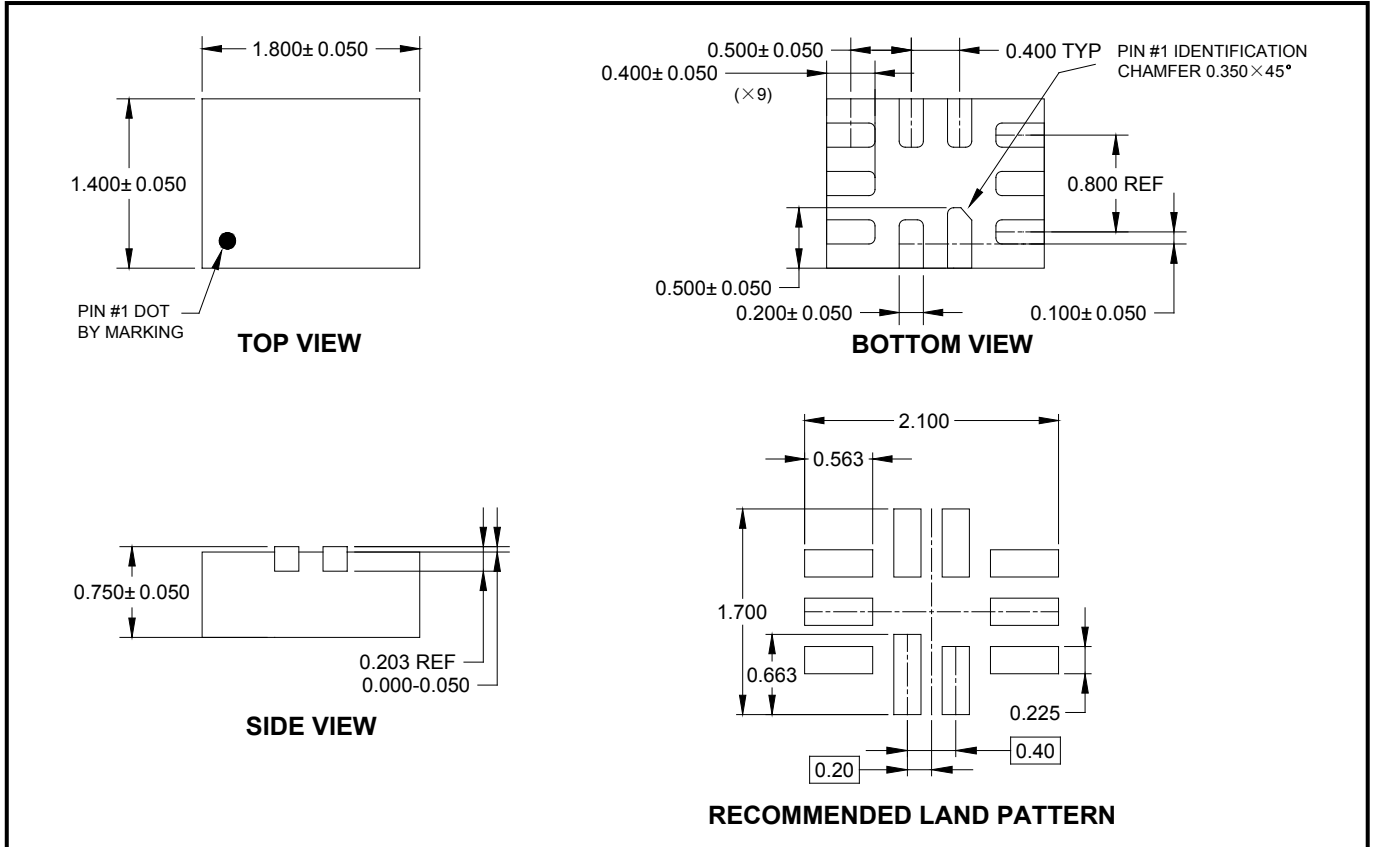

NOTE: All linear dimensions are in millimeters.

TAPE AND REEL INFORMATION

REEL DIMENSIONS



TAPE DIMENSIONS



NOTE: The picture is only for reference. Please make the object as the standard.

KEY PARAMETER LIST OF TAPE AND REEL

Package Type	Reel Diameter	Reel Width W1 (mm)	A0 (mm)	B0 (mm)	K0 (mm)	P0 (mm)	P1 (mm)	P2 (mm)	W (mm)	Pin1 Quadrant
TQFN-1.8×1.4-10L	7"	9.0	1.75	2.10	1.00	4.0	4.0	2.0	8.0	Q1

DD0001

PACKAGE INFORMATION

CARTON BOX DIMENSIONS



NOTE: The picture is only for reference. Please make the object as the standard.

KEY PARAMETER LIST OF CARTON BOX

Reel Type	Length (mm)	Width (mm)	Height (mm)	Pizza/Carton
7" (Option)	368	227	224	8
7"	442	410	224	18

DD0002