

GENERAL DESCRIPTION

The SGM2208 is a low noise, adjustable output and low dropout voltage linear regulator. It is capable of supplying 3A output current with typical dropout voltage of only 155mV. The operating input voltage range (relative to OUT) is from 0V to 24V and bias supply voltage range (relative to OUT) is from 2.7V to 25V.

Other features include output current limit and thermal shutdown protection. The output voltage of the SGM2208 can be adjusted flexibly with a single resistor and the output can be configured to 0V.

The SGM2208 is available in Green TSSOP-16 (Exposed Pad), TDFN-3x3-12L and TO-263-5B packages. It operates over an operating temperature range of -40°C to +125°C.

FEATURES

- **Operating Input Voltage Range (Relative to OUT): 0V to 24V**
- **Bias Supply Voltage Range (Relative to OUT): 2.7V to 25V**
- **Single Resistor Programs Output Voltage**
- **Output Adjustable to 0V**
- **SET Pin Current: 50µA (TYP)**
- **Low Dropout Voltage: 155mV (TYP) at 3A**
- **Low Output Noise: 32µV_{RMS} (TYP)**
- **Current Limiting and Thermal Protection**
- **-40°C to +125°C Operating Temperature Range**
- **Available in Green TSSOP-16 (Exposed Pad), TDFN-3x3-12L and TO-263-5B Packages**

APPLICATIONS

- Parallel Shunt Application
- Low Output Voltage Power Supplies
- DAC-Controlled Adjustable Power Supplies
- Programmable High Current Power Supplies

TYPICAL APPLICATION

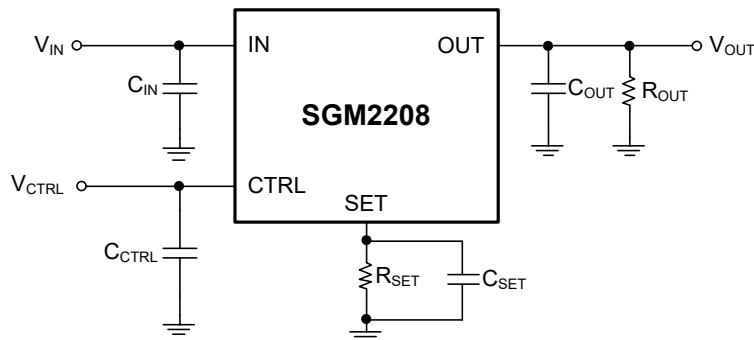

Figure 1. Typical Application Circuit

SGM2208 3A, Low Noise, Adjustable Output with Single Resistor and Low Dropout Regulator

PACKAGE/ORDERING INFORMATION

MODEL	PACKAGE DESCRIPTION	SPECIFIED TEMPERATURE RANGE	ORDERING NUMBER	PACKAGE MARKING	PACKING OPTION
SGM2208	TSSOP-16 (Exposed Pad)	-40°C to +125°C	SGM2208XPTS16G/TR	SGM2208 XPTS16 XXXXX	Tape and Reel, 4000
	TDFN-3×3-12L	-40°C to +125°C	SGM2208XTDF12G/TR	SGM 2208DF XXXXX	Tape and Reel, 4000
	TO-263-5B	-40°C to +125°C	SGM2208XO5G/TR	SGM2208 XO5 XXXXX	Tape and Reel, 800

MARKING INFORMATION

NOTE: XXXXX = Date Code, Trace Code and Vendor Code.

TSSOP-16 (Exposed Pad)/TDFN-3×3-12L/TO-263-5B

XXXXX

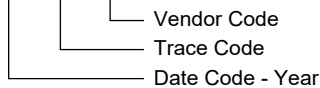

Green (RoHS & HSF): SG Micro Corp defines "Green" to mean Pb-Free (RoHS compatible) and free of halogen substances. If you have additional comments or questions, please contact your SGMICRO representative directly.

ABSOLUTE MAXIMUM RATINGS

CTRL to OUT	±28V
IN to OUT	-0.3V to 28V
SET to OUT	±15V
SET Pin Current	±25mA
Package Thermal Resistance	
TSSOP-16 (Exposed Pad), θ_{JA}	39°C/W
TSSOP-16 (Exposed Pad), θ_{JB}	16°C/W
TSSOP-16 (Exposed Pad), $\theta_{JC(TOP)}$	46°C/W
TSSOP-16 (Exposed Pad), $\theta_{JC(BOT)}$	2.1°C/W
TDFN-3×3-12L, θ_{JA}	62°C/W
TDFN-3×3-12L, θ_{JB}	27°C/W
TDFN-3×3-12L, $\theta_{JC(TOP)}$	41°C/W
TDFN-3×3-12L, $\theta_{JC(BOT)}$	1.04°C/W
TO-263-5B, θ_{JA}	29°C/W
TO-263-5B, θ_{JB}	9°C/W
TO-263-5B, $\theta_{JC(TOP)}$	32°C/W
TO-263-5B, $\theta_{JC(BOT)}$	1.86°C/W
Junction Temperature	+150°C
Storage Temperature Range	-65°C to +150°C
Lead Temperature (Soldering, 10s)	+260°C
ESD Susceptibility	
HBM	3000V
CDM	1000V

RECOMMENDED OPERATING CONDITIONS

Input Effective Capacitance, C_{IN}	10µF (MIN)
Output Effective Capacitance, C_{OUT}	10µF to 100µF
CTRL Effective Capacitance, C_{CTRL}	2.2µF (MIN)
Operating Junction Temperature Range	-40°C to +125°C

OVERSTRESS CAUTION

Stresses beyond those listed in Absolute Maximum Ratings may cause permanent damage to the device. Exposure to absolute maximum rating conditions for extended periods may affect reliability. Functional operation of the device at any conditions beyond those indicated in the Recommended Operating Conditions section is not implied.

ESD SENSITIVITY CAUTION

This integrated circuit can be damaged if ESD protections are not considered carefully. SGMICRO recommends that all integrated circuits be handled with appropriate precautions. Failure to observe proper handling and installation procedures can cause damage. ESD damage can range from subtle performance degradation to complete device failure. Precision integrated circuits may be more susceptible to damage because even small parametric changes could cause the device not to meet the published specifications.

DISCLAIMER

SG Micro Corp reserves the right to make any change in circuit design, or specifications without prior notice.

PIN CONFIGURATIONS

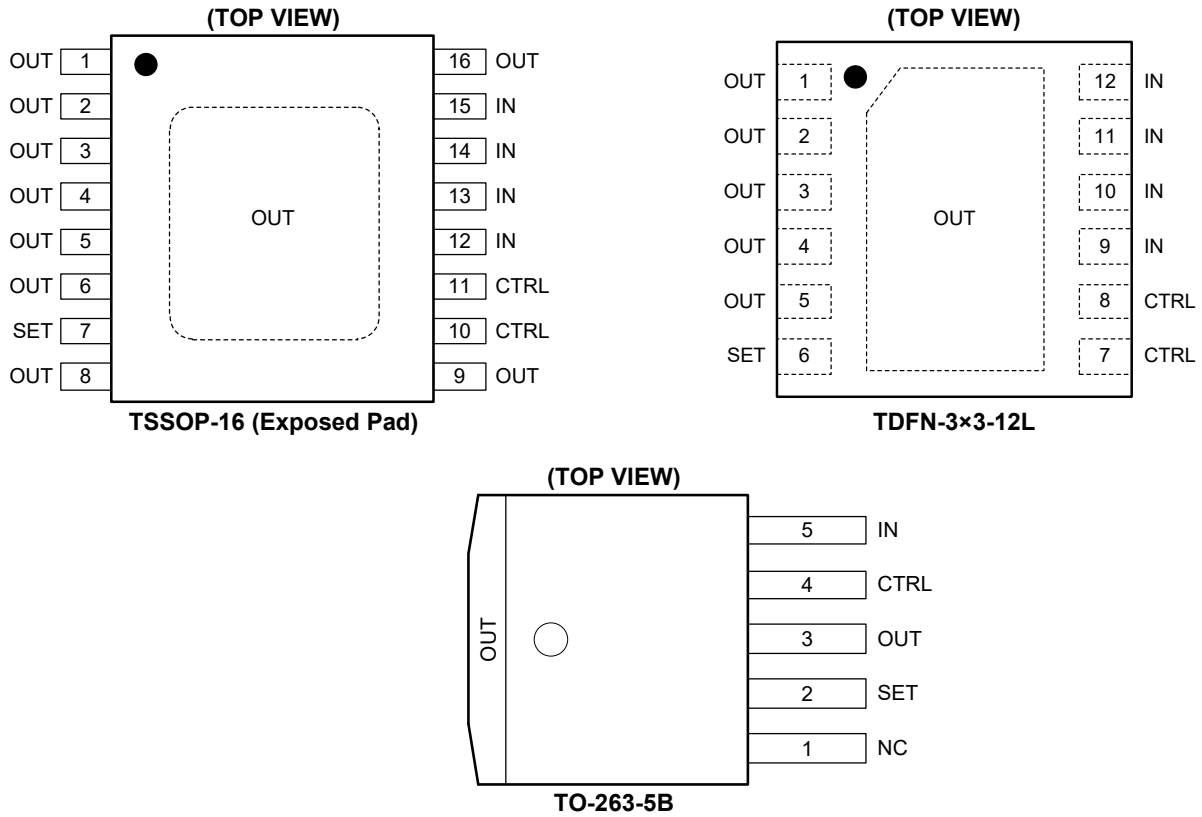

PIN DESCRIPTION

PIN			NAME	FUNCTION
TSSOP-16 (Exposed Pad)	TDFN-3x3-12L	TO-263-5B		
1-6, 8, 9, 16	1-5	3	OUT	Regulator Output Pin. It is recommended to use a ceramic capacitor with effective capacitance in the range of 10µF to 100µF to ensure stability. This ceramic capacitor should be placed as close as possible to OUT pin. A minimum load current of 1mA is required.
7	6	2	SET	Set Point Pin. This pin flows out a fixed reference current of 50µA through an external resistor to set the output voltage.
10, 11	7, 8	4	CTRL	Bias Voltage Supply Pin for Internal Control Circuits. It is recommended to use a ceramic capacitor with minimum effective capacitance of 2.2µF from CTRL pin to ground.
12-15	9-12	5	IN	Input Supply Voltage Pin. This pin provides the output load current. It is recommended to use a ceramic capacitor with minimum effective capacitance of 10µF from IN pin to ground. This ceramic capacitor should be placed as close as possible to IN pin.
-	-	1	NC	No Connection.
Exposed Pad	Exposed Pad	-	OUT	Regulated Output Pin (Exposed Pad). Connect it to the OUT plane on the board to maximize thermal performance; this pad is not an electrical connection point.

FUNCTIONAL BLOCK DIAGRAM

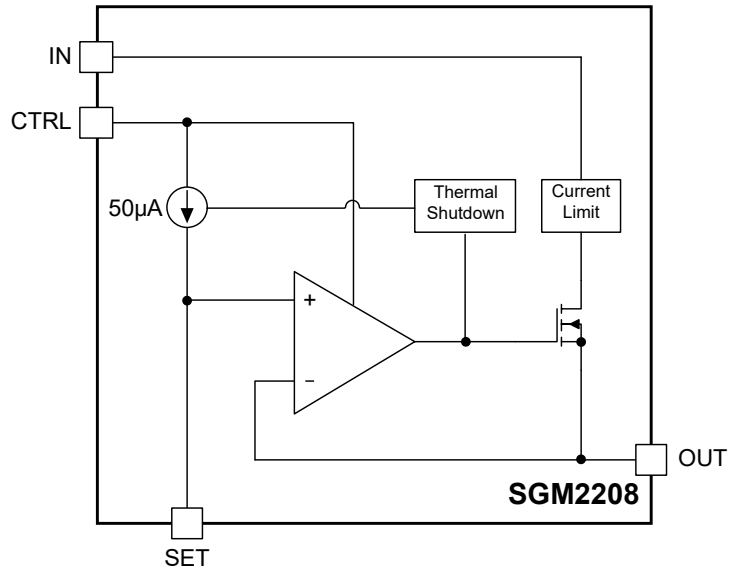

Figure 2. Block Diagram

ELECTRICAL CHARACTERISTICS

($V_{IN} = V_{OUT} + 0.5V$, $V_{CTRL} = V_{OUT} + 2.7V$, all voltages relative to V_{OUT} , $I_{OUT} = 1mA$, $C_{IN} = C_{OUT} = 10\mu F$, $C_{CTRL} = 2.2\mu F$ and $C_{SET} = 0.1\mu F$, $T_J = -40^\circ C$ to $+125^\circ C$, typical values are at $T_J = +25^\circ C$, unless otherwise noted.)

PARAMETER	SYMBOL	CONDITIONS	MIN	TYP	MAX	UNITS	
Bias Supply Voltage Range	V_{CTRL}		2.7		25	V	
Power Input Voltage Range	V_{IN}		V_{DROP}		24	V	
SET Pin Current	I_{SET}	$V_{IN} = (V_{OUT} + 0.5V)$ to $(V_{OUT} + 24V)$, $V_{CTRL} = (V_{OUT} + 2.7V)$ to $(V_{OUT} + 25V)$, $I_{OUT} = 1mA$ to $3A$	$T_J = +25^\circ C$ $T_J = -40^\circ C$ to $+125^\circ C$	49.5 49	50 51	50.5 51	μA
Output Offset Voltage ($V_{OUT} - V_{SET}$)	V_{OS}	$V_{IN} = (V_{OUT} + 0.5V)$ to $(V_{OUT} + 24V)$, $V_{CTRL} = (V_{OUT} + 2.7V)$ to $(V_{OUT} + 25V)$	$T_J = +25^\circ C$ $T_J = -40^\circ C$ to $+125^\circ C$	-5 -5.5		5 5.5	mV
Load Regulation	ΔI_{SET}	$I_{OUT} = 1mA$ to $3A$	$T_J = +25^\circ C$	-30	2	30	nA
			$T_J = -40^\circ C$ to $+125^\circ C$	-50		50	
	ΔV_{OS}	$I_{OUT} = 1mA$ to $3A$, TSSOP-16 (Exposed Pad)	$T_J = +25^\circ C$	-1	-0.2		mV
			$T_J = -40^\circ C$ to $+125^\circ C$	-1.6			
		$I_{OUT} = 1mA$ to $3A$, TDFN-3x3-12L	$T_J = +25^\circ C$	-1	-0.2		
			$T_J = -40^\circ C$ to $+125^\circ C$	-1.6			
$I_{OUT} = 1mA$ to $3A$, TO-263-5B	$T_J = +25^\circ C$	-1.6	-0.7				
	$T_J = -40^\circ C$ to $+125^\circ C$	-2.1					
V_{IN} Line Regulation	$\frac{\Delta I_{SET}}{\Delta V_{IN}}$	$V_{IN} = (V_{OUT} + 0.5V)$ to $(V_{OUT} + 24V)$	$T_J = +25^\circ C$		0.1	1	nA/V
			$T_J = -40^\circ C$ to $+125^\circ C$			12	
V_{CTRL} Line Regulation	$\frac{\Delta V_{OS}}{\Delta V_{CTRL}}$	$V_{CTRL} = (V_{OUT} + 2.7V)$ to $(V_{OUT} + 25V)$	$T_J = +25^\circ C$		0.001	0.015	mV/V
			$T_J = -40^\circ C$ to $+125^\circ C$			0.02	
V_{CTRL} Line Regulation	$\frac{\Delta I_{SET}}{\Delta V_{CTRL}}$	$V_{CTRL} = (V_{OUT} + 2.7V)$ to $(V_{OUT} + 25V)$	$T_J = +25^\circ C$		0.1	1	nA/V
			$T_J = -40^\circ C$ to $+125^\circ C$			12	
Minimum Load Current ⁽¹⁾		$V_{IN} = (V_{OUT} + 0.5V)$ to $(V_{OUT} + 24V)$, $V_{CTRL} = (V_{OUT} + 2.7V)$ to $(V_{OUT} + 25V)$	$T_J = +25^\circ C$		330	430	μA
			$T_J = -40^\circ C$ to $+125^\circ C$			490	
V_{IN} Dropout Voltage ⁽²⁾	V_{DROP}	$I_{OUT} = 3A$, TSSOP-16 (Exposed Pad)	$T_J = +25^\circ C$		155	210	mV
			$T_J = -40^\circ C$ to $+125^\circ C$			280	
		$I_{OUT} = 3A$, TDFN-3x3-12L	$T_J = +25^\circ C$		155	210	
			$T_J = -40^\circ C$ to $+125^\circ C$			280	
		$I_{OUT} = 3A$, TO-263-5B	$T_J = +25^\circ C$		245	300	
			$T_J = -40^\circ C$ to $+125^\circ C$			400	
CTRL Pin Current	I_{CTRL}	$I_{OUT} = 1mA$	$T_J = +25^\circ C$		310	410	μA
			$T_J = -40^\circ C$ to $+125^\circ C$			470	
		$I_{OUT} = 3A$	$T_J = +25^\circ C$		820	1040	
			$T_J = -40^\circ C$ to $+125^\circ C$			1110	
Output Current Limit	I_{LIMIT}	$V_{IN} = 1V$, $V_{SET} = 0V$, $V_{OUT} = -0.1V$, $T_J = +25^\circ C$	5.3	8		A	
Error Amplifier RMS Output Noise		$I_{OUT} = 500mA$, $f = 10Hz$ to $100kHz$		32		μV_{RMS}	
Reference Current RMS Output Noise		$I_{OUT} = 500mA$, $f = 10Hz$ to $100kHz$		1		nA_{RMS}	

ELECTRICAL CHARACTERISTICS (continued)

($V_{IN} = V_{OUT} + 0.5V$, $V_{CTRL} = V_{OUT} + 2.7V$, all voltages relative to V_{OUT} , $I_{OUT} = 1mA$, $C_{IN} = C_{OUT} = 10\mu F$, $C_{CTRL} = 2.2\mu F$ and $C_{SET} = 0.1\mu F$, $T_J = -40^\circ C$ to $+125^\circ C$, typical values are at $T_J = +25^\circ C$, unless otherwise noted.)

PARAMETER	SYMBOL	CONDITIONS	MIN	TYP	MAX	UNITS	
Power Supply Rejection Ratio	PSRR	$V_{CTRL} + V_{IN}$ to V_{OUT} , $V_{CTRL} = V_{IN} = V_{OUT} + 3V$, $I_{OUT} = 100mA$	$f = 120Hz$		80		dB
			$f = 10kHz$		47		
			$f = 1MHz$		43		
	PSRR	V_{CTRL} to V_{OUT} , $V_{CTRL} = V_{OUT} + 3V$, $I_{OUT} = 100mA$	$f = 120Hz$		88		dB
			$f = 10kHz$		63		
			$f = 1MHz$		87		
	PSRR	V_{IN} to V_{OUT} , $V_{IN} = V_{OUT} + 1V$, $I_{OUT} = 100mA$	$f = 120Hz$		70		dB
			$f = 10kHz$		40		
			$f = 1MHz$		37		
Thermal Shutdown Temperature	T_{SHDN}			160		$^\circ C$	
Thermal Shutdown Hysteresis	ΔT_{SHDN}			20		$^\circ C$	

NOTES:

1. Minimum load current refers to the minimum current to ensure the normal of the output voltage.
2. The dropout voltage is defined as the difference between V_{IN} and V_{OUT} when $V_{OS} = 50mV$.

TYPICAL PERFORMANCE CHARACTERISTICS

$T_J = +25^\circ\text{C}$, $I_{OUT} = 1\text{mA}$, $C_{IN} = C_{OUT} = 10\mu\text{F}$, $C_{CTRL} = 2.2\mu\text{F}$ and $C_{SET} = 0.1\mu\text{F}$, unless otherwise noted.

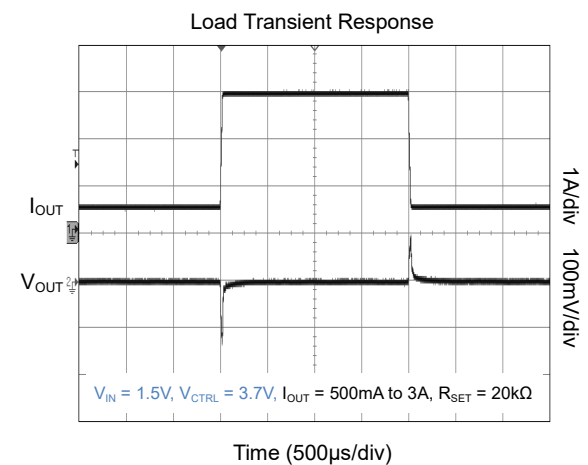
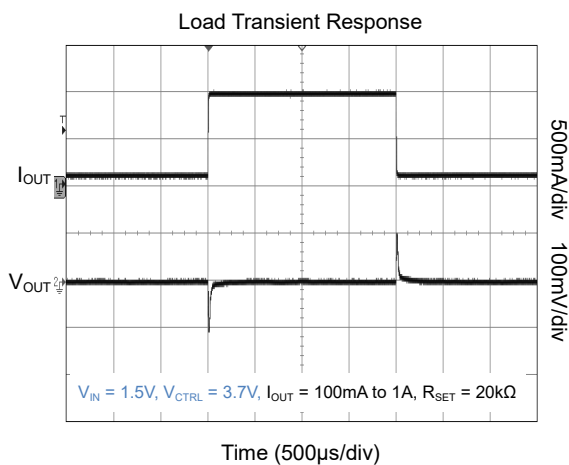
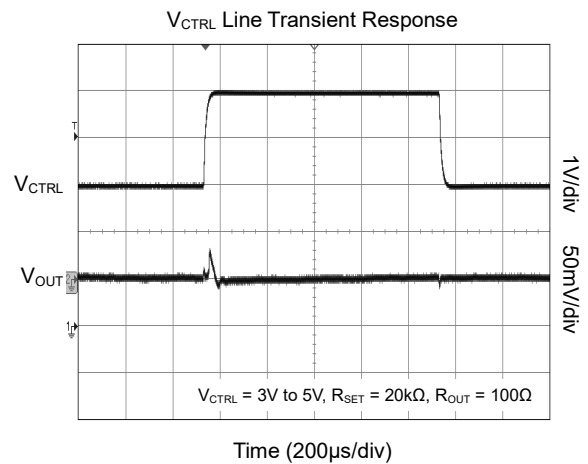
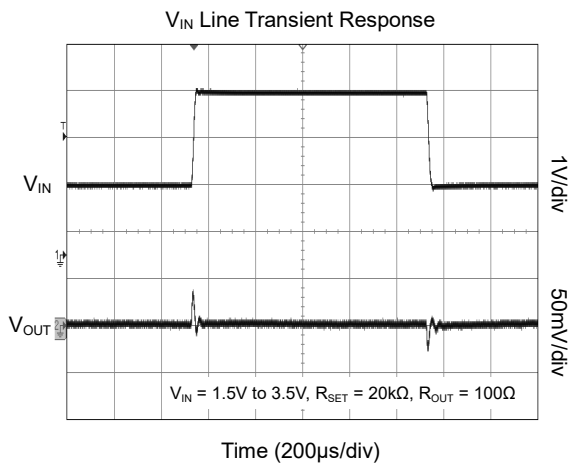
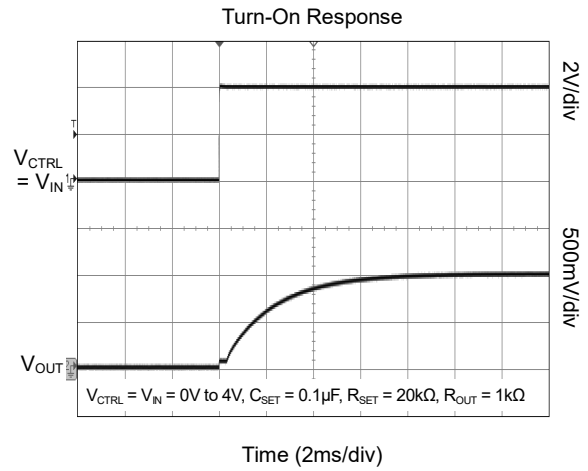
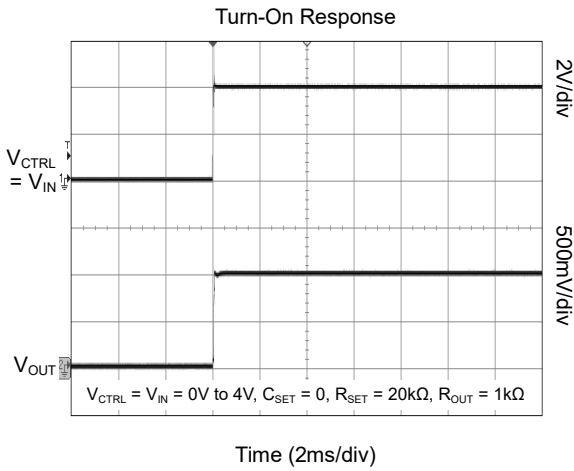

TYPICAL PERFORMANCE CHARACTERISTICS (continued)

T_J = +25°C, I_{OUT} = 1mA, C_{IN} = C_{OUT} = 10µF, C_{CTRL} = 2.2µF and C_{SET} = 0.1µF, unless otherwise noted.

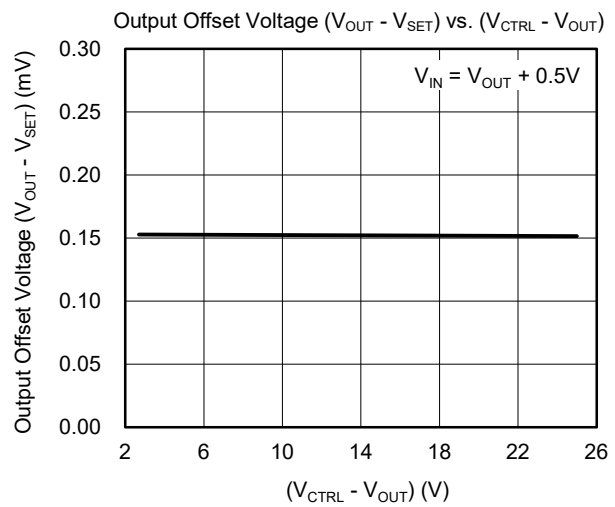
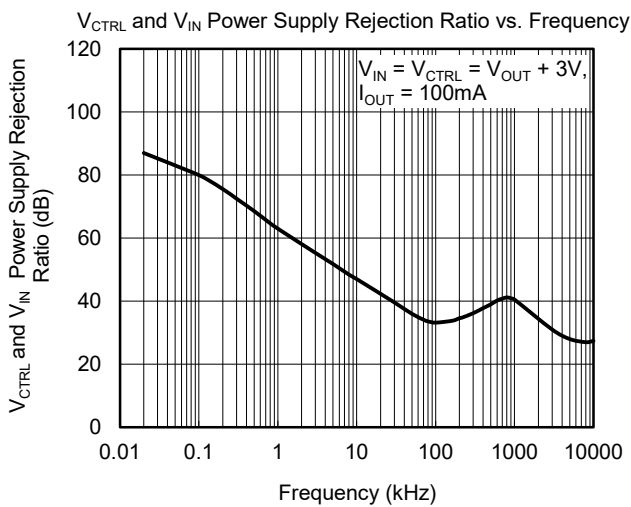
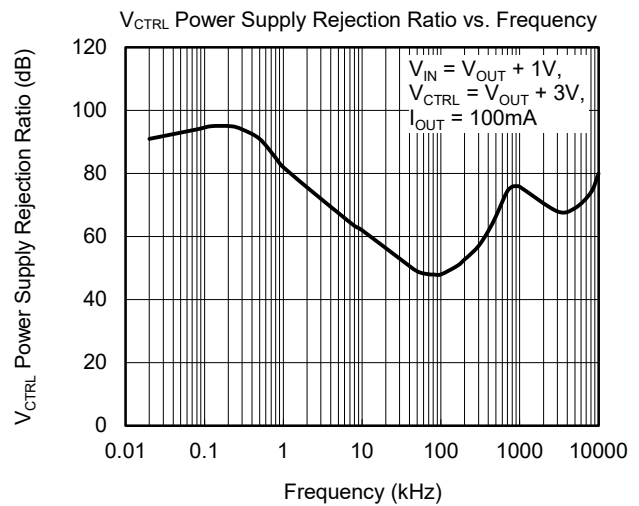
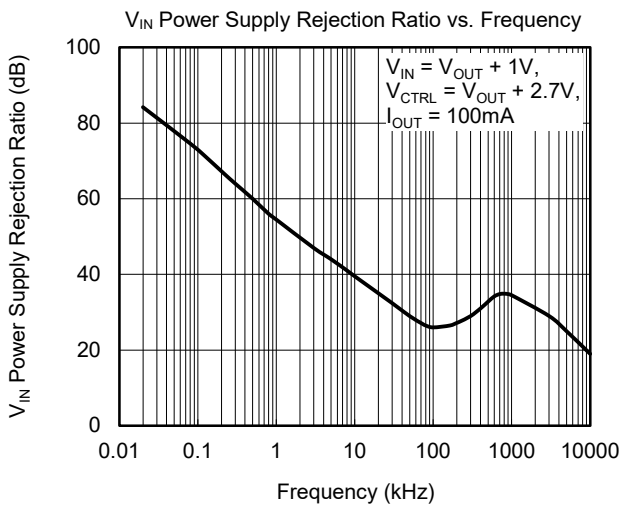
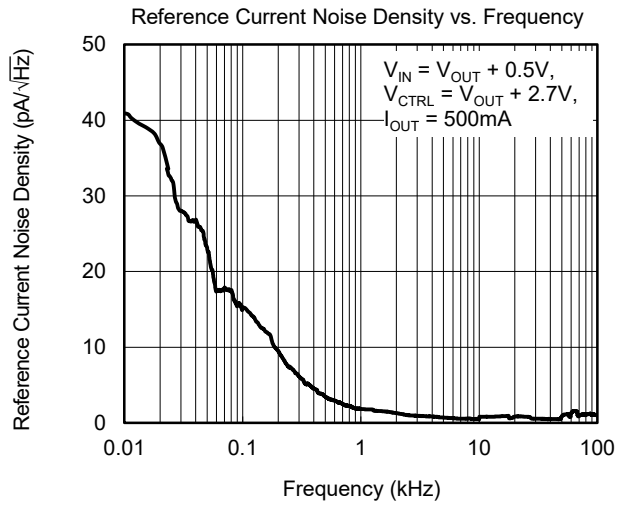
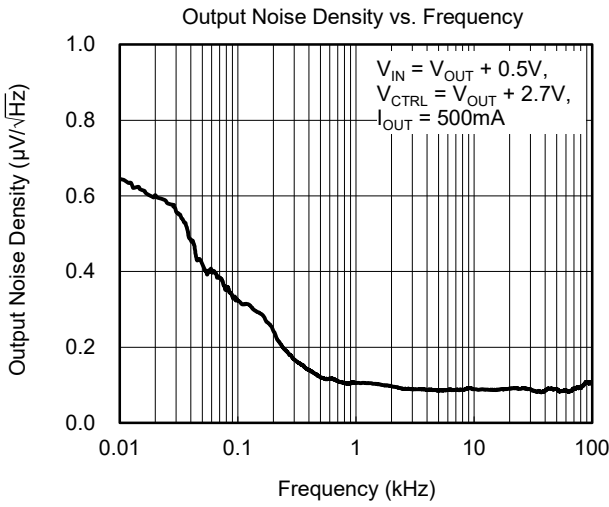

TYPICAL PERFORMANCE CHARACTERISTICS (continued)

T_J = +25°C, I_{OUT} = 1mA, C_{IN} = C_{OUT} = 10µF, C_{CTRL} = 2.2µF and C_{SET} = 0.1µF, unless otherwise noted.

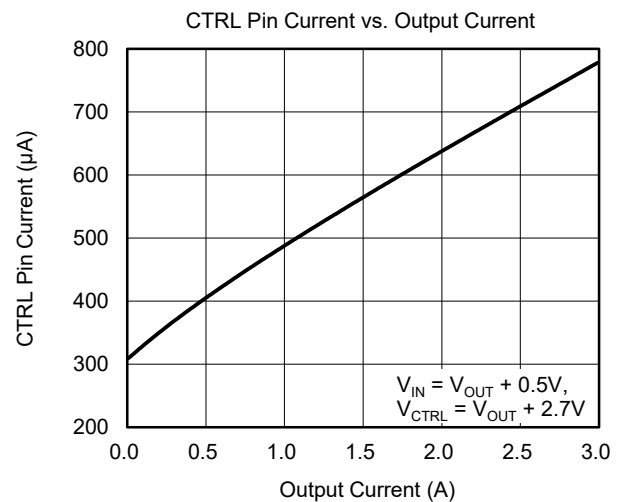
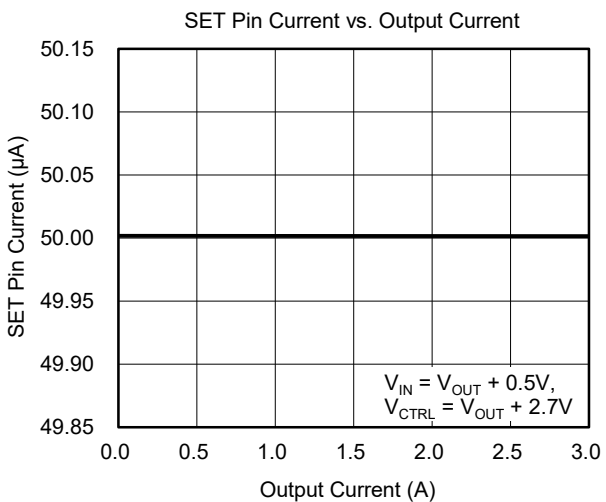
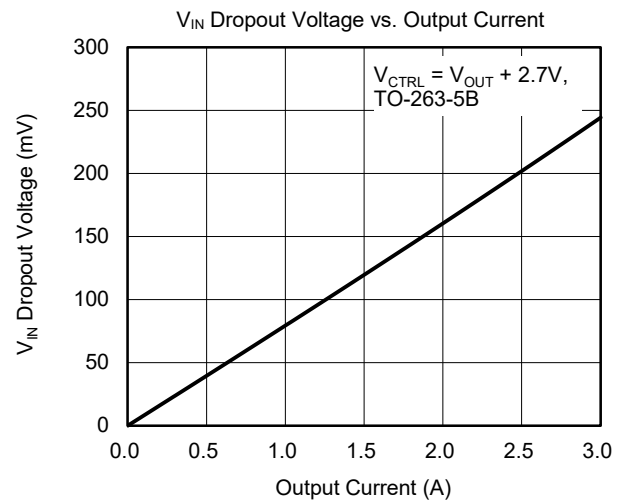
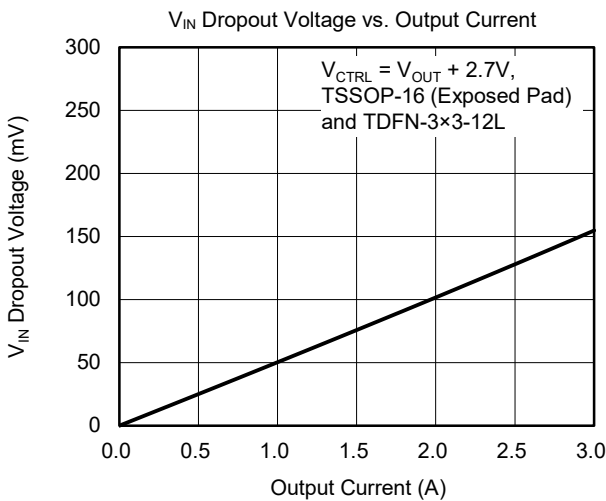
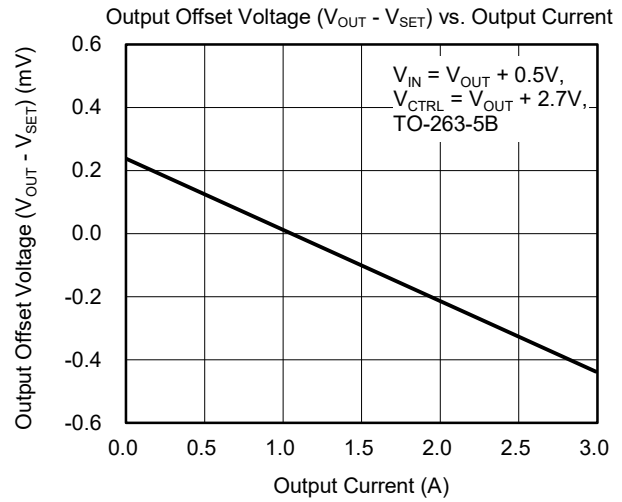
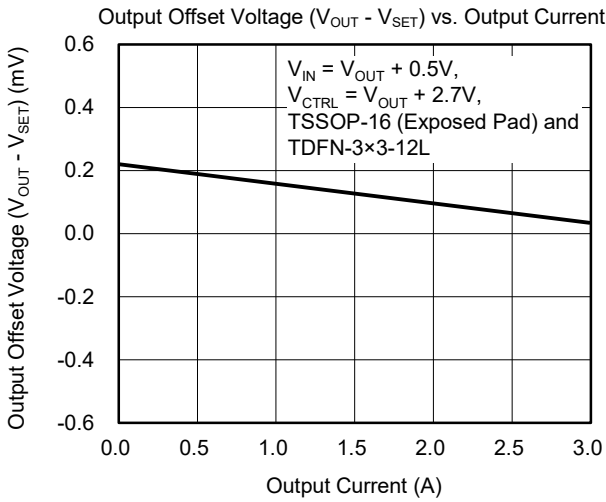

TYPICAL PERFORMANCE CHARACTERISTICS (continued)

$T_J = +25^\circ\text{C}$, $V_{IN} = V_{OUT(NOM)} + 0.5\text{V}$, $V_{CTRL} = V_{OUT(NOM)} + 2.7\text{V}$, $I_{OUT} = 1\text{mA}$, $C_{IN} = C_{OUT} = 10\mu\text{F}$, $C_{CTRL} = 2.2\mu\text{F}$ and $C_{SET} = 0.1\mu\text{F}$, unless otherwise noted.

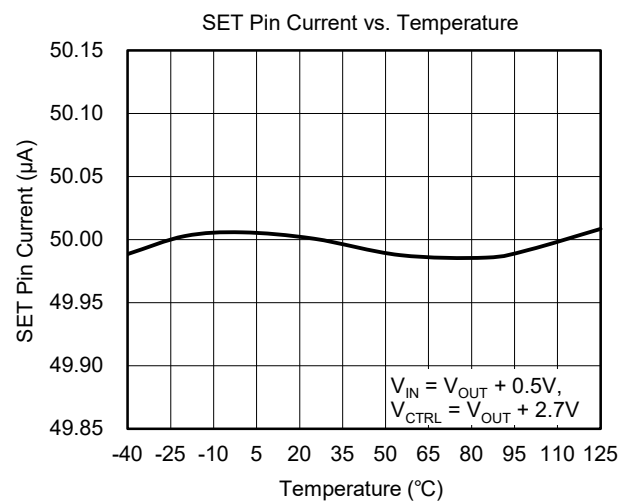
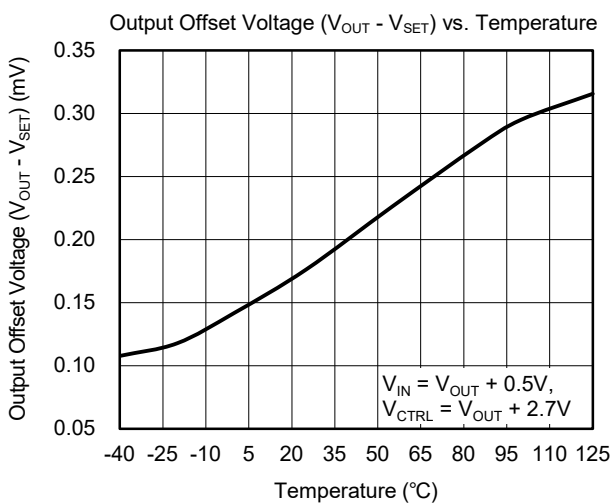
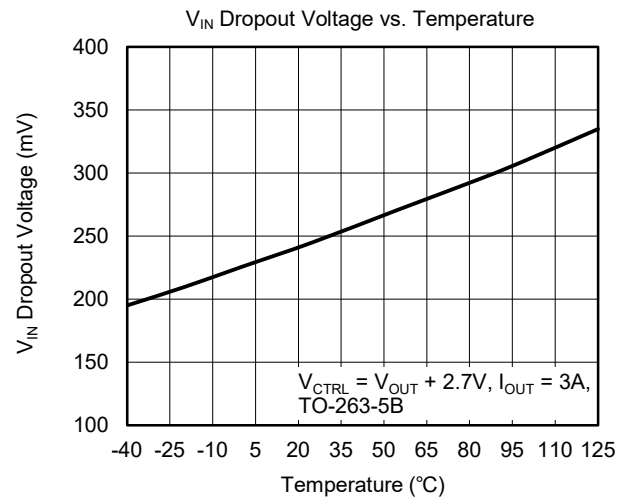
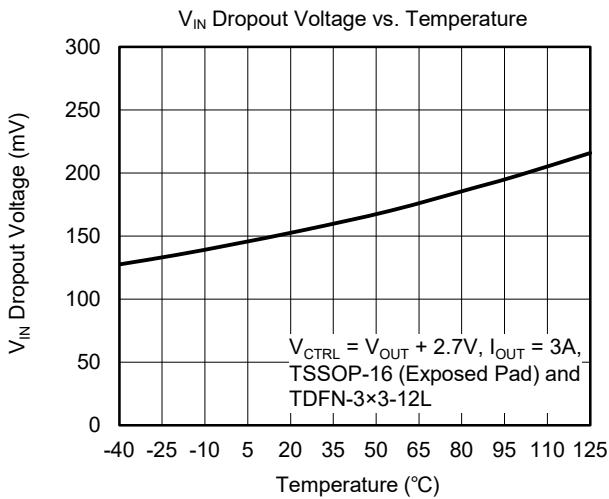
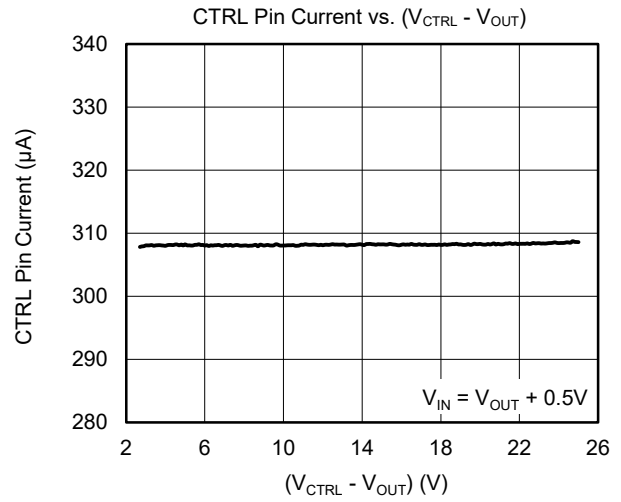
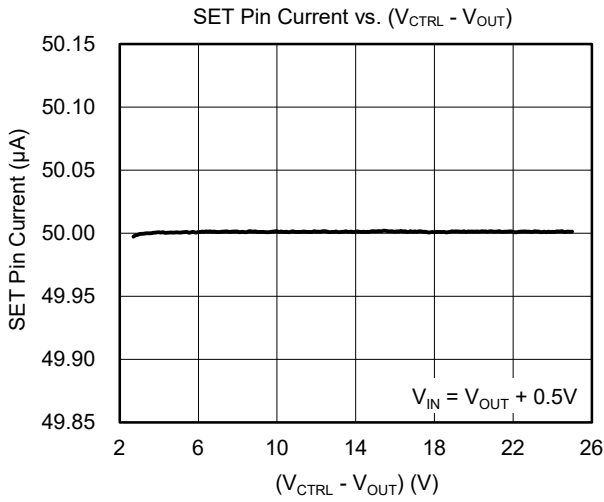

APPLICATION INFORMATION

The SGM2208 is a low noise, adjustable output and low dropout voltage LDO and provides 3A output current. By using a reference current through a single resistor, the output voltage is programmed to any level. These features make the device a reliable solution to solve many challenging problems in the generation of clean and accurate power supply. The high performance also makes the SGM2208 useful in a variety of applications. The SGM2208 provides protection functions for output overload and overheating.

Input Capacitor Selection (C_{IN}, C_{CTRL})

The input decoupling capacitor should be placed as close as possible to the IN pin and the CTRL pin to ensure the device stability. The minimum effective capacitance of C_{IN} is 10µF and C_{CTRL} is 2.2µF. X7R or X5R ceramic capacitors are selected to get good dynamic performance.

Output Capacitor Selection (C_{OUT})

The output decoupling capacitor should be placed as close as possible to the OUT pin. The minimum effective capacitance of C_{OUT} that SGM2208 can remain stable is 10µF. For ceramic capacitor, temperature, DC bias and package size will change the effective capacitance, so enough margin of C_{OUT} must be considered in design. Additionally, C_{OUT} with larger capacitance and lower ESR will help increase the high frequency PSRR and improve the load transient response.

Output Current Limit

When overload events happen, the output current is internally limited to 8A (TYP).

Adjustable Output Voltage

The output voltage of the SGM2208 can be adjusted with a single resistor (R_{SET}) as shown in Figure 3. A fixed reference current of 50µA flows out of the SET pin through R_{SET} to set the output voltage of the error amplifier. The output voltage is determined by the following equation:

$$V_{OUT} = 50\mu A \times R_{SET} \tag{1}$$

One parallel capacitor (C_{SET}) with R_{SET} can be used to improve the stability and PSRR, increase the transient

response and reduce the output noise. A 1mA minimum load current is required to regulate the output voltage.

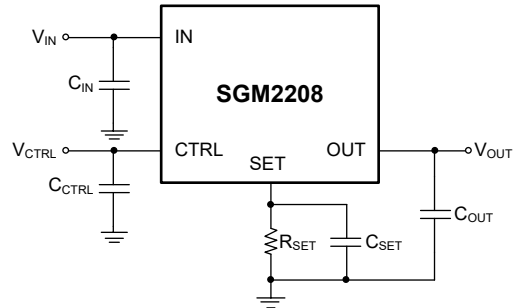

Figure 3. Adjustable Output Voltage Application

Devices Parallel Application

As shown in Figure 4, when high output current is required, multiple SGM2208 devices can be used in parallel. The SET pins of the device should be connected together, as should the IN pins. A resistor R_B is added to the output of each device, which acts as a ballast to improve the parity of current between parallel devices.

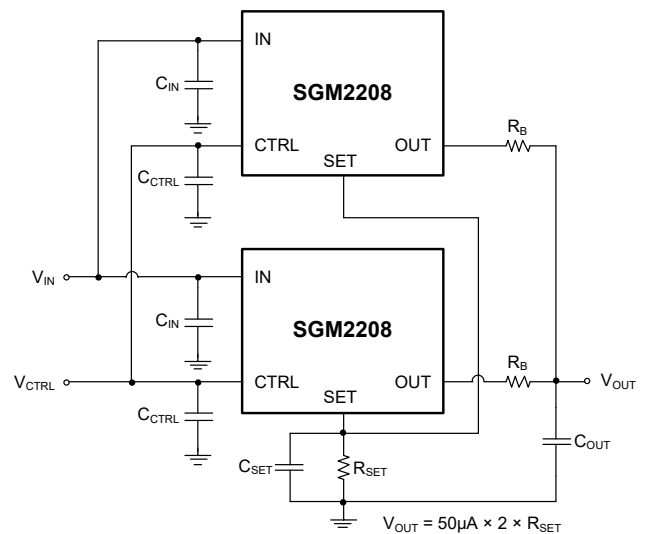

Figure 4. Devices Parallel Application

Thermal Shutdown

The SGM2208 can detect the temperature of die. When the die temperature exceeds the threshold value of thermal shutdown, the SGM2208 will be in shutdown state and it will remain in this state until the die temperature decreases to +140°C.

REVISION HISTORY

NOTE: Page numbers for previous revisions may differ from page numbers in the current version.

SEPTEMBER 2022 – REV.A.2 to REV.A.3	Page
Updated Package Thermal Resistance	2

APRIL 2022 – REV.A.1 to REV.A.2	Page
Updated Typical Performance Characteristics section	6-9

DECEMBER 2020 – REV.A to REV.A.1	Page
Updated Application Information section	11

Changes from Original (DECEMBER 2019) to REV.A	Page
Changed from product preview to production data	All

PACKAGE OUTLINE DIMENSIONS

TSSOP-16 (Exposed Pad)

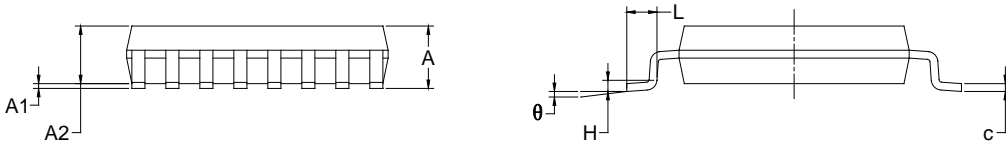
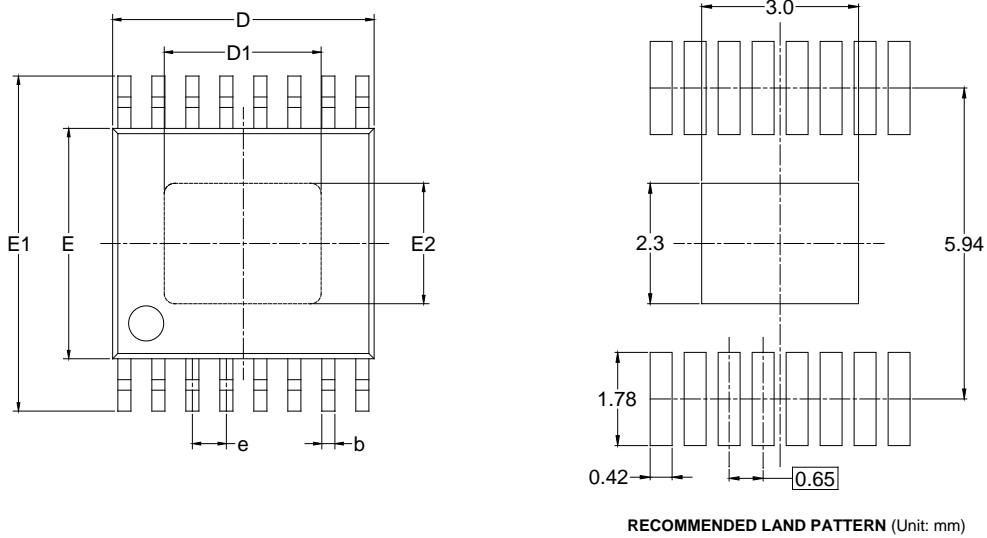

Symbol	Dimensions In Millimeters		Dimensions In Inches	
	MIN	MAX	MIN	MAX
A		1.100		0.043
A1	0.050	0.150	0.002	0.006
A2	0.800	1.000	0.031	0.039
b	0.190	0.300	0.007	0.012
c	0.090	0.200	0.004	0.008
D	4.900	5.100	0.193	0.201
D1	2.900	3.100	0.114	0.122
E	4.300	4.500	0.169	0.177
E1	6.250	6.550	0.246	0.258
E2	2.200	2.400	0.087	0.094
e	0.650 BSC		0.026 BSC	
L	0.500	0.700	0.02	0.028
H	0.25 TYP		0.01 TYP	
θ	1°	7°	1°	7°

NOTES:
 1. Body dimensions do not include mode flash or protrusion.
 2. This drawing is subject to change without notice.

PACKAGE OUTLINE DIMENSIONS

TDFN-3x3-12L

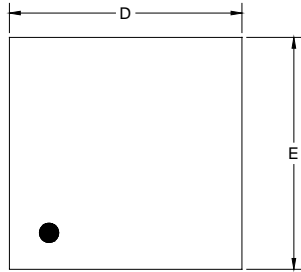

TOP VIEW

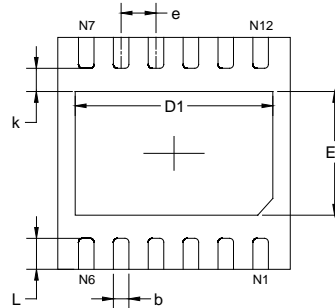

BOTTOM VIEW



SIDE VIEW

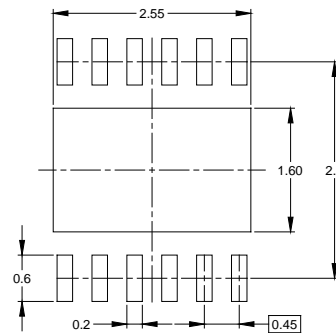

RECOMMENDED LAND PATTERN (Unit: mm)

Symbol	Dimensions In Millimeters		Dimensions In Inches	
	MIN	MAX	MIN	MAX
A	0.700	0.800	0.028	0.031
A1	0.000	0.050	0.000	0.002
A2	0.203 REF		0.008 REF	
D	2.924	3.076	0.115	0.121
D1	2.450	2.650	0.096	0.104
E	2.924	3.076	0.115	0.121
E1	1.500	1.700	0.059	0.067
k	0.200 MIN		0.008 MIN	
b	0.150	0.250	0.006	0.010
e	0.450 TYP		0.018 TYP	
L	0.324	0.476	0.013	0.019

NOTE: This drawing is subject to change without notice.

PACKAGE OUTLINE DIMENSIONS

TO-263-5B

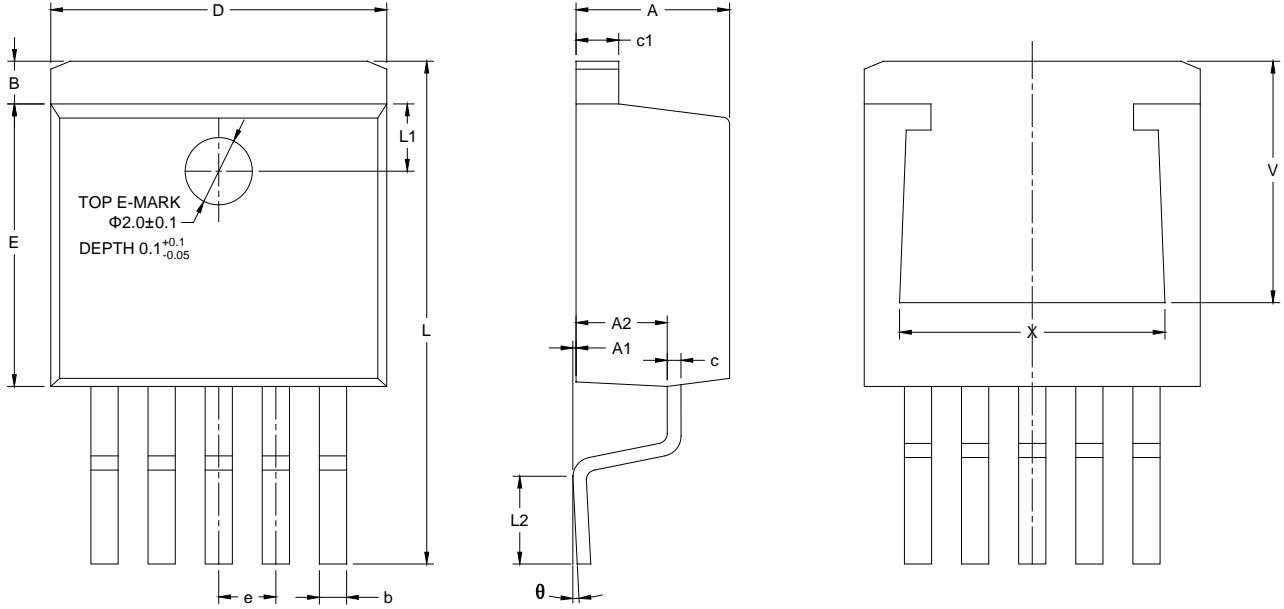

Symbol	Dimensions In Millimeters		
	MIN	MOD	MAX
A	4.40	4.57	4.70
A1	0	0.10	0.25
A2	2.59	2.69	2.79
b	0.77	-	0.90
c	0.34	-	0.47
c1	1.22	-	1.32
e	1.70 BSC		
D	10.06	10.16	10.26
E	9.05	9.15	9.25
B	1.17	1.27	1.40
V	6.86	-	7.50
X	7.50	-	8.30
L	14.70	15.10	15.50
L1	2.00 REF		
L2	2.00	2.30	2.60
θ	0°	-	8°

NOTES:

1. Body dimensions do not include mode flash or protrusion.
2. This drawing is subject to change without notice.

PACKAGE INFORMATION

TAPE AND REEL INFORMATION

REEL DIMENSIONS

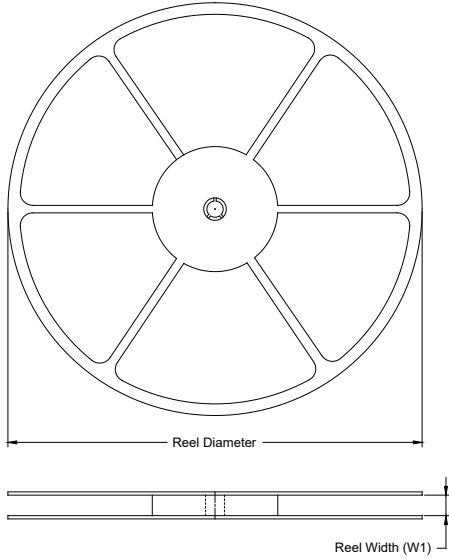

TAPE DIMENSIONS



NOTE: The picture is only for reference. Please make the object as the standard.

KEY PARAMETER LIST OF TAPE AND REEL

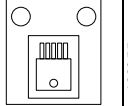
Package Type	Reel Diameter	Reel Width W1 (mm)	A0 (mm)	B0 (mm)	K0 (mm)	P0 (mm)	P1 (mm)	P2 (mm)	W (mm)	Pin1 Quadrant
TSSOP-16 (Exposed Pad)	13"	12.4	6.90	5.60	1.50	4.0	8.0	2.0	12.0	Q1
TDFN-3×3-12L	13"	12.4	3.30	3.30	1.10	4.0	8.0	2.0	12.0	Q1
TO-263-5B	13"	24.4	10.80	16.30	5.11	4.0	16.0	2.0	24.0	

DD0001

PACKAGE INFORMATION

CARTON BOX DIMENSIONS



NOTE: The picture is only for reference. Please make the object as the standard.

KEY PARAMETER LIST OF CARTON BOX

Reel Type	Length (mm)	Width (mm)	Height (mm)	Pizza/Carton
13"	386	280	370	5

DD0002