

Varied Lineup to meet your requirement

Application	GPS		GPS L1/L2	GPS/GLONASS	Beidou	Iridium
Series/ Part No.	PASSIVE	ACTIVE	PASSIVE	ACTIVE	PASSIVE	PASSIVE
	MHA-1575A MHB-1575A/C MHD-1575A	MHC-1575D/E MHC-1575G/H	MHF-1401A	MHC-1589A	MHE-1561A	MHE-1621A MHF-1621A/B
Outlook						
Outer Size [mm]	Φ7.6×16.5 Φ13.3×34.0 Φ19.0×33.0	Φ13.3×34.0 Φ14.8×44.6	Φ19.0×49.4	Φ14.8×44.6	Φ14.6×27.3	Φ14.6×27.3 Φ14.6×42.6 Φ18.5×44.6
RoHS	○		○	○	○	○
Frequency [MHz]	1575		1228/1575	1575/1602	1561	1621
Directionality [deg]	135		135	135	135	135
GAIN [dBic]	MHA : -5 MHB/D : -3	MHC 1575D/E : 16 1575G/H : 25	L1 : -5 L2 : -3	25	-1	MHE : -1 MHF : 2
LNA	-	○	-	○	-	-
BAND	single		dual	dual	single	single
Mould Item	MHD-1575A		-	-	-	MHF-1621B
RTK applied	-		○	○	-	-

"The dielectric-loaded helical antenna solution"

MHF-1621B

Rugged Iridium dielectric loaded antenna: SMA (male)

APPLICATIONS

- Iridium Satellite Telephones
- Iridium Messaging Terminals
- Logistics Management
- Research bouys
- Asset Tracking/Messaging
- Emergency Location
- Disaster Communications

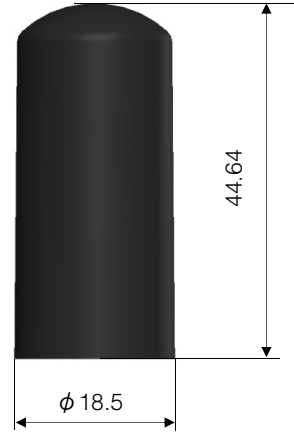

Product Description

The rugged MHF-1621B antenna is a durable elastomeric-plastic overmoulded and dielectric-loaded decafilax-helix antenna which uses MARUWA's distinctive materials technology to provide the highest available efficiency in a small size. The dielectric core together with the fly-wheeling effect of the advanced decafilax helical design provide excellent beamwidth and low elevation gain, which is maintained in relatively cluttered use scenarios. The MHF-1621B acts as its own filter, attenuating signals from common cellular and ISM frequencies by as much as 30dB.

Key Features

- Highest available efficiency per unit of volume
- Excellent beamwidth and low elevation gain
- Relatively unimpaired by cluttering objects
- Designed for harsh environments: exposed to force, dust and moisture
- Base flange groove for O-ring water-seal

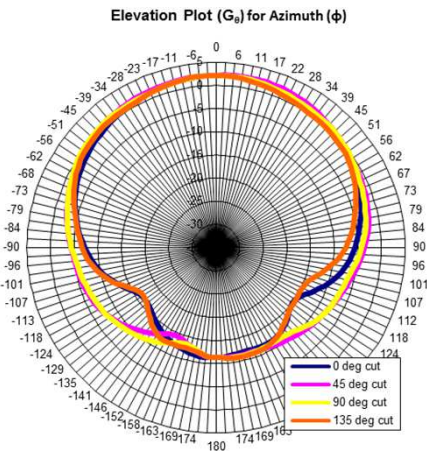

Design Specifications	Typical	Units
Frequency	1621.0	MHz
Gain (RHCP)	+2.0	dBic at zenith
Beamwidth	> 135	Degrees
Bandwidth	20	MHz
Axial Ratio	<1.5	at zenith
VSWR	<2.0:1	-
Impedance	50	Ohms
Operating Temp	-40→+85	°C
Weight	29	grams

MHF-1621A

Iridium dielectric loaded antenna: SMA (male)

APPLICATIONS

- Iridium Satellite Telephones
- Iridium Messaging Terminals
- Logistics Management
- Research bouys
- Asset Tracking/Messaging
- Emergency Location
- Disaster Communications

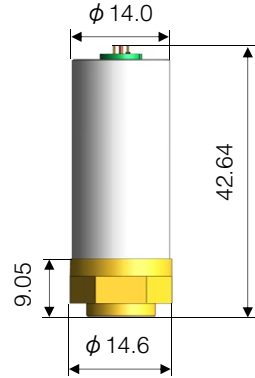

Product Description

The MHF-1621A antenna is a dielectric-loaded decafilax-helix antenna which uses distinctive materials technology to provide the highest available efficiency in a small size. The dielectric core together with the fly-wheeling effect of the advanced decafilax helical design provide excellent beamwidth and low elevation gain, which is maintained in relatively cluttered use scenarios. The MHF-1621 acts as its own filter, attenuating signals from common cellular and ISM frequencies by as much as 30dB.

Key Features

- Designed for installation with 10mm gap from antenna side to host PCB ground-plane
- Filters against interference from cellular and ISM bands
- Balanced design rejects common mode noise from ground plane
- Solder-pad installation to device PCB

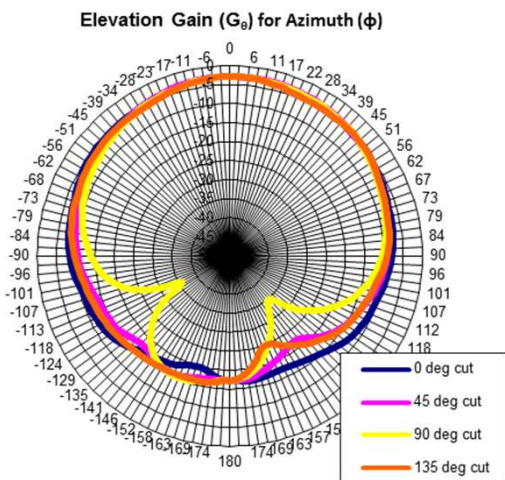

Design Specifications	Typical	Units
Frequency	1621.0	MHz
Gain (RHCP)	+2.0	dBic at zenith
Beamwidth	>135	Degrees
Bandwidth	20	MHz
Axial Ratio	<1.5	at zenith
VSWR	<2.0:1	-
Impedance	50	Ohms
Operating Temp	-40→+85	°C
Weight	27	grams

MHE-1621A

Iridium dielectric loaded antenna: SMA male connection

APPLICATIONS

- Iridium Satellite Telephones
- Iridium Messaging Terminal
- Logistics Management
- Research bouys
- Asset Tracking/Messaging
- Emergency Location
- Disaster Communications

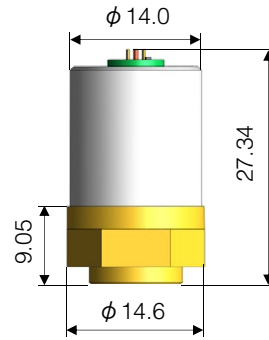

Product Description

The MHE-1621A antenna is a dielectric-loaded decafilax-helix antenna which uses distinctive materials technology to provide the highest available efficiency in a small size. The dielectric core together with the fly-wheeling effect of the advanced decafilax helical design provide excellent beamwidth and low elevation gain, which is maintained in relatively cluttered use scenarios. The MHE-1621A acts as its own filter, attenuating signals from common cellular and ISM frequencies by as much as 30dB.

Key Features

- Designed for installation with 10mm gap from antenna side to host PCB ground-plane
- Filters against interference from cellular and ISM bands
- Balanced design rejects common mode noise from ground plane
- Solder-pad installation to device PCB

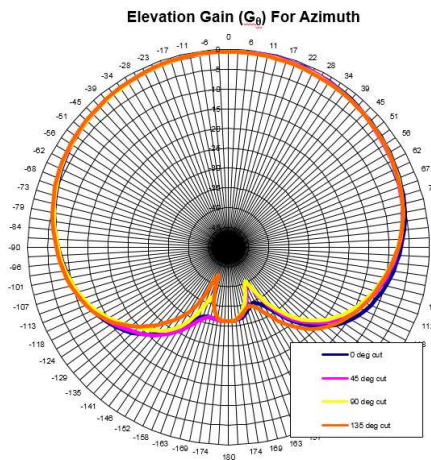

Design Specifications	Typical	Units
Frequency	1621.0	MHz
Gain (RHCP)	-0.5	dBic at zenith
Beamwidth	>135	Degrees
Bandwidth	20	MHz
Axial Ratio	<1.5	at zenith
VSWR	<2.0:1	-
Impedance	50	Ohms
Operating Temp	-40 +85	
Weight	16	grams

MHE-1561A

BeiDou B1 dielectric loaded antenna: SMA male connection

APPLICATIONS

- Asset Tracking
- Hand Held Devices
- UAV/AUV
- Traffic Enforcement
- Emergency Location
- Seismic Monitors/Measuring
- Wildlife Tracking
- Marine Tracking

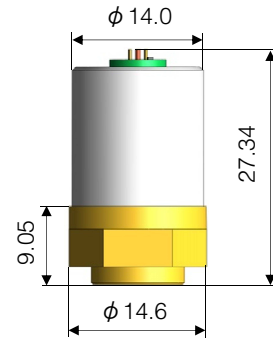

Product Description

The MHE-1561A antenna is a dielectric-loaded decafililar-helix antenna which uses distinctive materials technology to provide the highest available efficiency in a small size. The dielectric core together with the fly-wheeling effect of the advanced decafililar helical design provide excellent beamwidth and low elevation gain, which is maintained in relatively cluttered use scenarios. The MHE-1561A acts as its own filter, attenuating signals from common cellular and ISM frequencies by as much as 30dB.

Key Features

- Designed for installation with 10mm gap from antenna side to host PCB ground-plane
- Filters against interference from cellular and ISM bands
- Balanced design rejects common mode noise from ground plane
- SMA male connection to device PCB

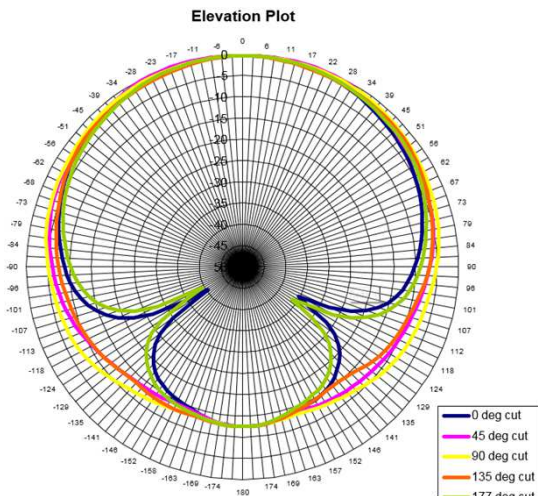

Design Specifications	Typical	Units
Frequency	1561.10	MHz
Gain (RHCP)	-0.5	dBic at zenith
Beamwidth	>135	Degrees
Bandwidth	20	MHz
Axial Ratio	<1.5	at zenith
VSWR	<2.0:1	-
Impedance	50	Ohms
Operating Temp	-40→+85	°C
Weight	16	grams

MHC-1589A

GPS/GLONASS miniture high-gain active dielectric loaded antenna

APPLICATIONS

- Asset Tracking
- Hand Held Devices
- UAV/AUV
- Vehicle GPS/GLONASS
- Emergency Location
- Seismic Monitors/Measuring
- Wildlife Tracking
- Marine Tracking

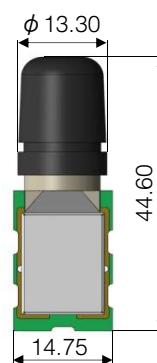

Product Description

The MHC-1589A GPS/GLONASS miniature high-gain active dielectric-loaded antenna uses Maruwa's distinctive materials technology to provide unrivaled circularly-polarized gain from a uniquely small volume. It enables excellent GPS/GLONASS performance in tightly integrated devices that require good positional accuracy. By combining a high-quality dielectric antenna with a high-performance low-noise amplifier the MHC-1589A active antenna provides an excellent solution for applications needing active gain input.

Key Features

- Negligible detuning in cluttered, dielectric loaded environments (hand-held, body-worn, close proximity to objects)
- Filters against interference from cellular and ISM bands
- Balanced design rejects common mode noise from ground plane
- Solder-pad installation to device PCB

Elevation Plot @ 1575MHz RHCP

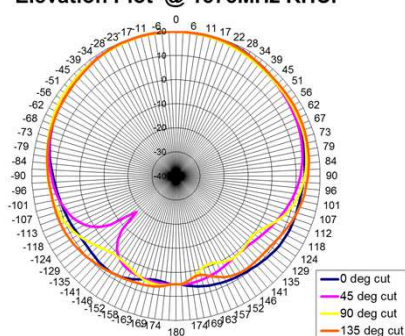

Elevation Plot @ 1602MHz RHCP

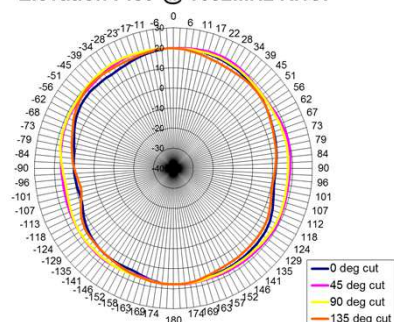

Design Specifications	Typical	Units
Frequency	1575.42	MHz
	1601.72	MHz
Voltage (range)	2.8→3.6	V
Current	13	mA
Gain (RHCP)	+20	dBic at zenith
Beamwidth	>135	Degrees
Bandwidth	20	MHz
Axial Ratio	<2.0	at zenith
VSWR	<2.0:1	-
Impedance	50	Ohms
Noise figure	1	dB
Operating Temp	-40→+80	°C
Weight	9.0	grams

"The dielectric-loaded helical antennas solution"

MHF-1401A

Rugged L1/L2 GPS dielectric loaded antenna : SMA (male)

APPLICATIONS

- Asset Tracking
- Hand Held Devices
- UAV/AUV
- Vehicle GPS
- Emergency Location
- Net Radio Location/Synchronisation
- Seismic Monitors/Measuring
- Marine Tracking

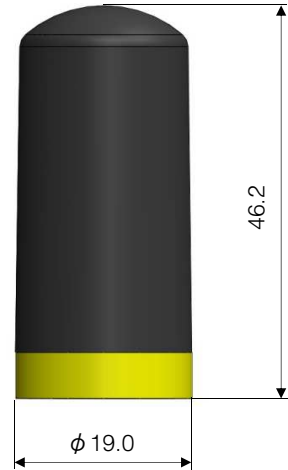

Product Description

The MHF-1401A is balanced, isolating it from the device and enabling the antenna to reject common mode noise. The design and materials of the antenna constrain its near-field to a very small volume. Therefore materials near the antenna have negligible de-tuning effects and the antenna maintains its pattern and efficiency in the presence of dielectric loading.

Typical Elevation Gain Pattern at GPS L1 (1.57542GHz)
Elevation Plot (G_e) for Azimuth (φ)

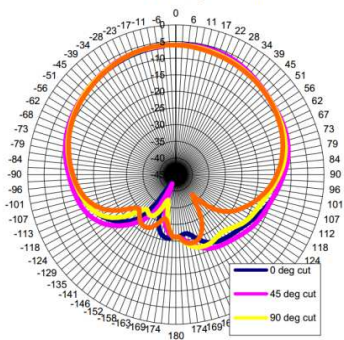

Typical Elevation Gain Pattern at GPS L2 (1.2276GHz)
Elevation Plot (G_e) for Azimuth (φ)

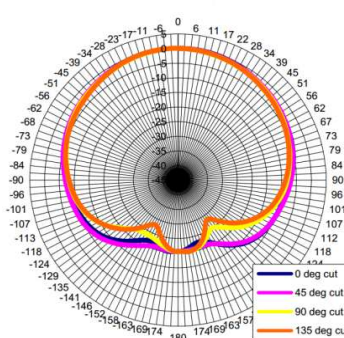

Key Features

- Negligible detuning in cluttered, dielectric loaded environments (hand-held, body-worn, close proximity to objects)
- Designed for harsh environments: exposed to force, dust and moisture
- Useable in scenarios where orientation of antenna is random
- Filters against interference from cellular and ISM bands
- Base flange groove for O-ring water-seal

Design Specifications	L1 Typical	L2 Typical	Units
Frequency	1575.42	1227.60	MHz
Gain (RHCP)	-4.5	-2.0	dBic at zenith
Beamwidth	>135	>135	Degrees
Bandwidth	>24	>24	MHz
Axial Ratio	<1.5	<1.5	at zenith
VSWR	<2.0:1	<2.0:1	-
Impedance	50	50	Ohms
Operating Temp	-40 → +85		°C

MHC-1575G

MHC-1575H

L1 GPS miniature high-gain active dielectric loaded antenna

APPLICATIONS

- Asset Tracking
- Hand Held Devices
- UAV/AUV
- Traffic Enforcement
- Emergency Location
- Seismic Monitors/Measuring
- Wildlife Tracking
- Marine Tracking

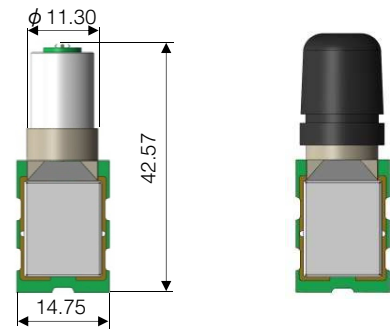

MHC-1575G

MHC-1575H

Product Description

The MHC-1575G/H GPS L1 miniature high-gain active dielectric-loaded antenna uses Maruwa's distinctive materials technology to provide unrivaled circularly-polarized gain from a uniquely small volume. It enables excellent GPS performance in tightly integrated devices that require good positional accuracy. By combining a high-quality dielectric antenna with a high-performance low-noise amplifier the MHC-1575G/H active antenna provides an excellent solution for applications needing active gain input.

Key Features

- Negligible detuning in cluttered, dielectric loaded environments (hand-held, body-worn, close proximity to objects)
- Filters against interference from cellular and ISM bands
- Balanced design rejects common mode noise from ground plane
- Solder-pad installation to device PCB

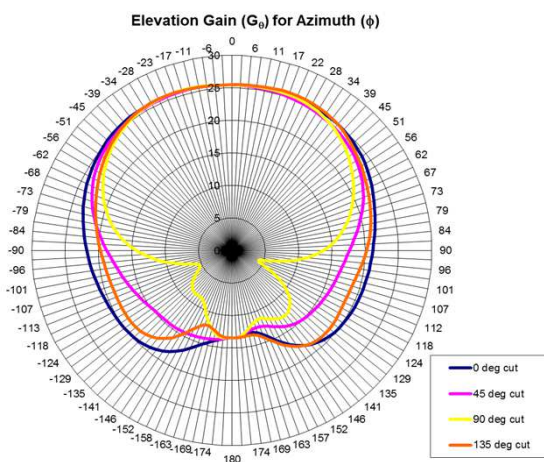

Design Specifications	Typical	Units
Frequency	1575.42	MHz
Voltage (range)	2.8→3.6	V
Current	13	mA
Gain (RHCP)	+25	dBic at zenith
Beamwidth	>135	Degrees
Bandwidth	20	MHz
Axial Ratio	<2.0	at zenith
VSWR	<2.0:1	-
Impedance	50	Ohms
Noise figure	1	dB
Operating Temp	-40→+85	°C
Weight	8.4	grams

MHD-1575A

Rugged L1 GPS dielectric loaded antenna: SMA (male)

APPLICATIONS

- Asset Tracking
- Hand Held Devices
- UAV/AUV
- Vehicle GPS
- Emergency Locators
- Net Radio Location/Synchronisation
- Seismic Monitors/Measuring
- Marine Tracking

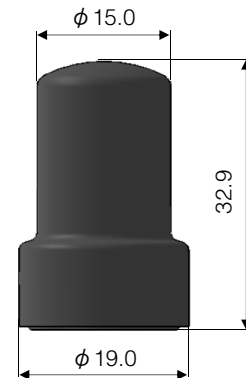

Product Description

The rugged MHD-1575A antenna is balanced, isolating it from the device and enabling the antenna to reject common mode noise. The design and materials of the antenna constrain its near-field to a very small volume. Therefore materials near the antenna have negligible de-tuning effects and the antenna maintains its pattern and efficiency in the presence of dielectric loading. The rugged MHD-1575A acts as its own filter, attenuating signals from common cellular and ISM frequencies by as much as 30dB. The MHD-1575A has a built in DC block to enable direct connection to receivers with DC on their input pin.

Key Features

- Negligible detuning in cluttered, dielectric loaded environments (hand-held, body-worn, close proximity to objects)
- Designed for harsh environments: exposed to force, dust and moisture
- Useable in scenarios where orientation of antenna is random
- Filters against interference from cellular and ISM bands
- Integrated O-ring water-seal

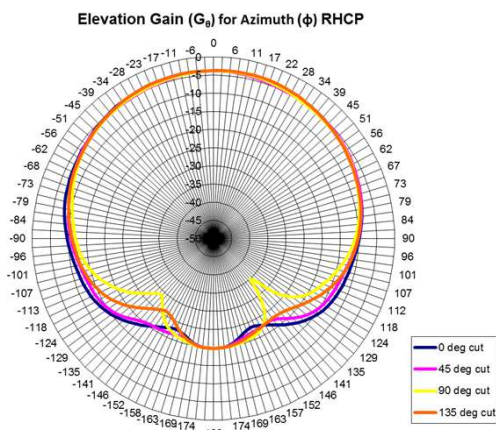

Design Specifications	Typical	Units
Frequency	1575.42	MHz
Gain (RHCP)	-3.0	dBic at zenith
Beamwidth	> 135	Degrees
Bandwidth	15	MHz
Axial Ratio	< 1.5	at zenith
VSWR	< 2.0:1	-
Impedance	50	Ohms
Operating Temp	-40 → +85	°C
Weight	14	grams

MHB-1575A

L1 GPS miniture dielectric loaded antenna : 3-pin connection

APPLICATIONS

- Asset Tracking
- Hand Held Devices
- UAV/AUV
- Traffic Enforcement
- Emergency Location
- Seismic Monitors/Measuring
- Wildlife Tracking
- Marine Tracking

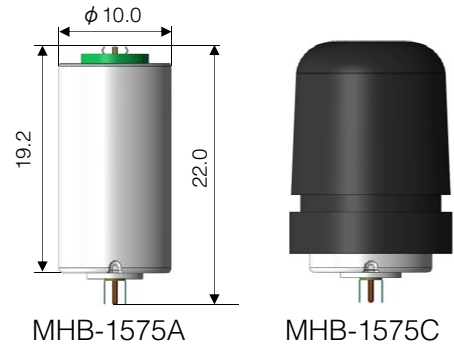

Product Description

The MHB-1575A is breakthrough GPS L1 miniature dielectric-loaded antenna which uses MARUWA's distinctive materials technology to provide circularly-polarized gain from a small volume where the housing environment causes a higher degree of frequency down-tuning. For more tightly integrated applications the alternative MHB-1575A should be selected. This together with the high relative dielectric constant of the core ensures excellent performance in tightly integrated applications.

Key Features

- Designed for installation with 10mm gap from antenna side to host PCB ground-plane
- Filters against interference from cellular and ISM bands
- Balanced design rejects common mode noise from ground plane
- Solder-pad installation to device PCB

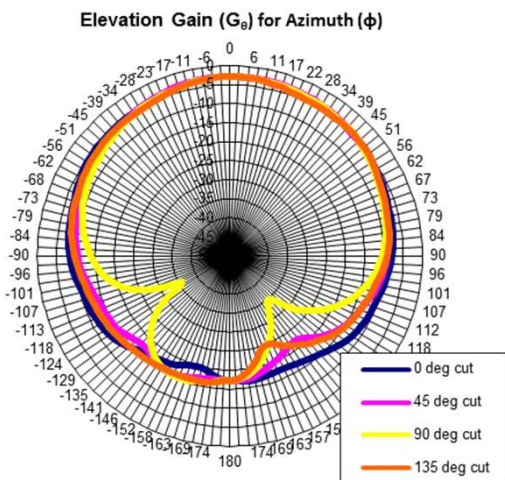

Design Specifications	Typical	Units
Frequency	1575.42	MHz
Gain (RHCP)	-3.0	dBic at zenith
Beamwidth	>135	Degrees
Bandwidth	15	MHz
Axial Ratio	<2.0	at zenith
VSWR	<2.0:1	-
Impedance	50	Ohms
Operating Temp	-40→+85	°C
Weight	7	grams

MHA-1575A

L1 GPS miniature dielectric loaded antenna : PCB feed

APPLICATIONS

- Asset Tracking
- Hand Held Devices
- UAV/AUV
- Traffic Enforcement
- Emergency Location
- Seismic Monitors/Measuring
- Wildlife Tracking
- Marine Tracking

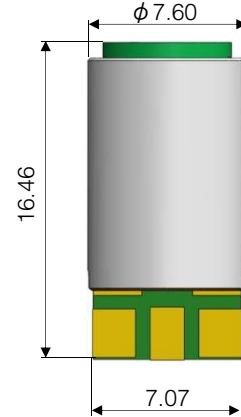

Product Description

The MHA-1575A is a breakthrough GPS L1 dielectric-loaded antenna which uses MARUWA's distinctive materials technology to provide unrivalled circularly-polarized gain from a uniquely small volume. The dielectric core together with the flywheel effect of the advanced design provides excellent performance in the most tightly integrated applications. The MHA-1575A acts as its own filter, attenuating signals from common cellular and ISM frequencies by as much as 30dB.

Key Features

- Designed for installation with 1.5mm gap from antenna side to host PCB ground-plane
- Filters against interference from cellular and ISM bands
- Balanced design rejects common mode noise from ground plane
- Solder-pad installation to device PCB

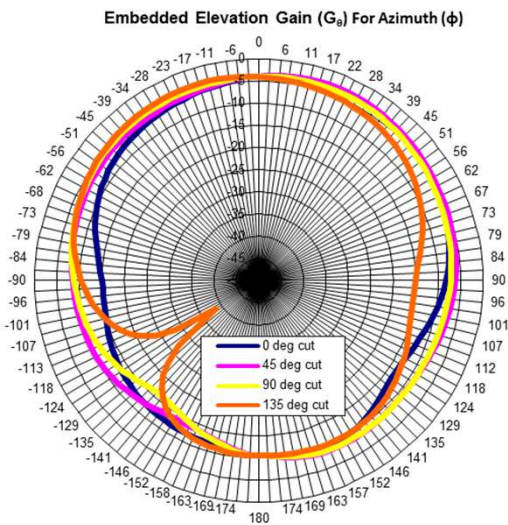

Design Specifications	Typical	Units
Frequency	1575.42	MHz
Gain (RHCP)	-3.5	dBic at zenith
Beamwidth	>135	Degrees
Bandwidth	15	MHz
Axial Ratio	<1.5	at zenith
VSWR	<2.0:1	-
Impedance	50	Ohms
Operating Temp	-40→+85	°C
Weight	3	grams

Maruwa - Sarantel Antenna

Varied Types Of Antenna - Compact Size, High Performance, Multiband, ACTIVE, PASSIVE, etc.

Are you wondering if there's GNSS antenna with a particular performance? MARUWA can offer you a good variety of product lineup for GNSS Antenna by using its long time experience & expertise for ceramic technology.

MARUWA's antenna can be used in a lot of different applications, design concepts and we meet customers' varied requirements.

Features for Sarantel Antenna

Helical Conformation is applied to MARUWA's Dielectric Ceramic and our antenna has 4 features as follows.

1. Wide Beam-width
2. Jamming-Resistant
3. Insusceptible to human body
4. Compact Size

1. Wide Beam-width

Due to its wide beam-width, Sarantel Antenna can be attached at any angles.

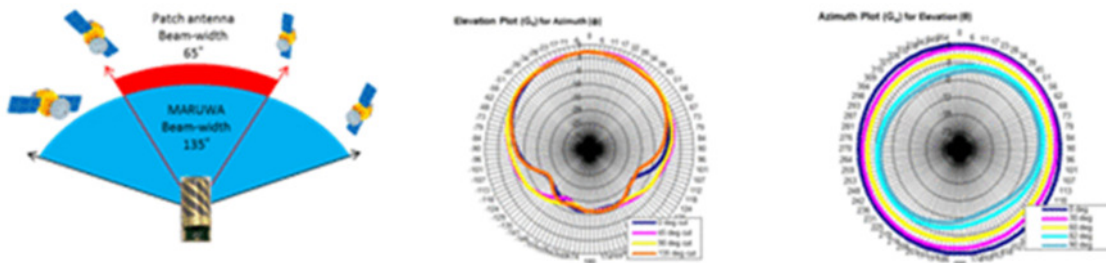

2. Jamming-Resistant



When receiving radio waves in the gap between buildings or trees, antenna receive signals from satellites and signals reflected by interference. In case of GPS, it calculate the location by using distance from the satellite. The actual signals from satellite and reflected signals are different in the route and if antenna recognizes both are correct signals, the result may become

inaccurate.

As Sarantel Antennas are designed to receive the signals from satellite more strongly and less strongly to the reflected signals, they are jamming-resistant and calculate the location very precisely.

3. Insusceptible to human body

Sarantel Antenna demonstrates high interference resistance. The chart on right hand side shows feature of "Return Loss";

1. Case 1: Free space only for antennas without the mobile device
2. Case 2: Antenna placed in the mobile device and holding it by hand
3. Case 3: Antenna placed in the mobile device and holding it by hand and close to human body

As Sarantel Antenna does not get interfered by human body, it shows high performance and feature.

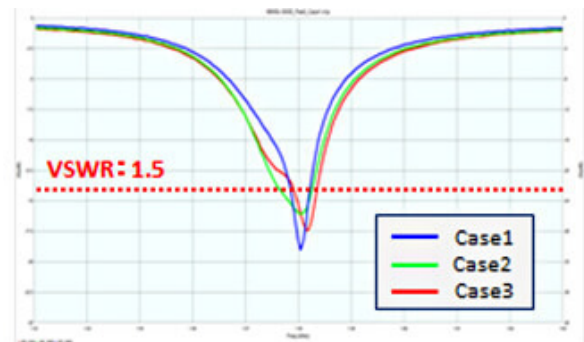

Graphs of Return Loss for Case1 - 3

4. Compact Size

Compact size is realized by using its high Q dielectric Ceramic.

MARUWA' Technology

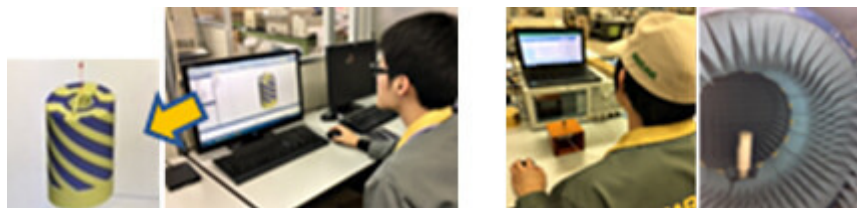

We can support fast development with our simulation technology and measuring facility.

Do you have issues with following problems?

- **Cannot adjust the attachment position of Antenna**
"Wish to have antenna, which can receive the signal in different angled position"

⇒ All Antennas. Sarantel Antenna can receive signal at leaned angles.

- **Looking for the antenna which can receive the signal under severe circumstances.**
"Wish for water-proof / dust-proofing antenna"

⇒ MHD-1575A, Sarantel Antennas meet MIL Standard and they are "robust"

- **Antenna is picking noise**
"Wish for antennas which don't pick noise too much."

⇒ MHC-1575G/E or MHC-1589A

2 layered filter is applied at LNA, which gives Jamming-Resistant effect. They don't get affected by temperature due to constant current circuit

- **Don't know how to attach the antennas**
"Want to know how to attach antenna with image"

⇒ All Antennas, We have application instruction. Please feel free to ask any question such as adjusting frequency etc.

Sample image for attaching antenna

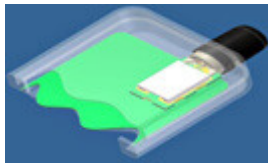

Attaching image - outer attachment

Antenna can be seen from outside of finished product

In case of Radome option, you don't need to worry about the frequency decline affect by device case when you design.



Attaching image - inner attachment

Antenna cannot be seen from outside of finished product

You have to consider the frequency decline affect by the device case.